



Antonio Valentin

CATÁLOGO GENERAL  
HERRAMIENTAS ESPECIALES  
PARA TRABAJAR LA PIEDRA

30 Años  
1977 - 2007





HERRAMIENTA DE ACERO	3 - 4	
HERRAMIENTA DE WIDIA	5 - 6	
ÚTILES DE MEDICIÓN	7	
BUJARDAS Y MACETAS	8	
GUBIAS PARA MADERA	9	
ESPATULINES Y LIMAS DIAMANTADAS	10	
LIMAS DE ACERO	11	
HERRAMIENTA DE WIDIA	12	
MARTILLOS NEUMÁTICOS LABRANTES Y REPUESTOS	13	
CARROS PARA ABUJARDAR	14	
TRABAJO EN CANTERA	15 - 16	
POLEAS Y GOMAS	17	
EMBALAJE	18	
FRESAS PARA MOLDURAS	20	
GRANDES DIÁMETROS	21	
LIJAS DE DIAMANTE 3M	22	
ÚTILES DIAMANTADOS	23 - 27	
ÚTILES DIAMANTADOS ELECTRODEPOSITADO	28	

HERRAMIENTA DE DIAMANTE ELECTRODEPOSITADO	29	
LIJAS Y PLATOS	30	
CARBORUNDUM DE SILICIO	31	
PRODUCTOS PARA TRATAMIENTO DE LA PIEDRA	32	
OTROS ÚTILES	33	
GRAPAS DE ACERO INOXIDABLE	34	
HERRAMIENTA NEUMÁTICA	35 - 36	
MAQUINARIA ELÉCTRICA	37 - 38	
PULIDORAS Y ABRILLANTADORAS	39	
CONSUMIBLES PARA PULIDO Y ABRILLANTADO DE PIEDRA	40 - 41	
CORTADORAS PORTÁTILES Y EQUIPOS DE CHORRO DE ARENA	42	
CONSUMIBLES Y REPUESTOS PARA CHORRO DE ARENA	43	
CARROS PARA EL TRANSPORTE DE PIEDRA	44	
PINZAS	45 - 46	
MANEJO DE CARGAS	47	
VENTOSAS	48	
ANTIDESLIZANTES	49	
PROTECCIÓN	50 - 51	





GRADINAS

Ref.	Boca
029316	11 mm.
029317	14 mm.
029318	20 mm.



ESCAFILADOR

Ref.
029314



CUÑA O PINCHOTE

Ref.	029309



MARCAPUNTOS

Ref.
029308



CINCELES

Ref.	Boca
029320	4 mm.
029321	6 mm.
029322	8 mm.
029323	10 mm.
029324	12 mm.
029325	14 mm.
029326	16 mm.
029327	20 mm.





CALADOS	
Ref.	Tamaño
029300	Grande
029301	Mediano
029302	Pequeño



MEDIA CAÑAS	
Ref.	Tamaño
029311	Grande
029312	Pequeño

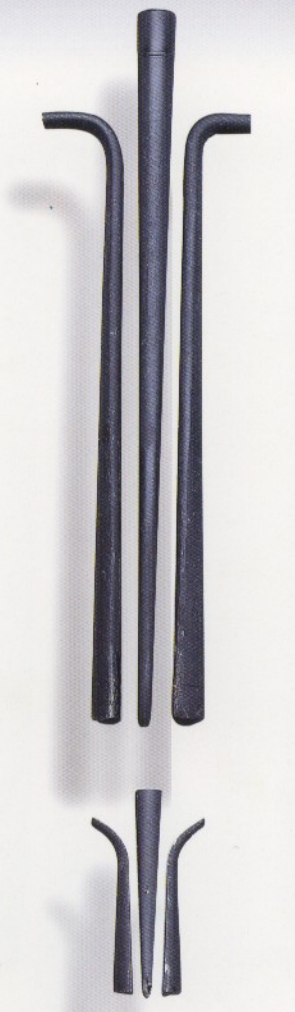

CUÑAS DE LENGÜETA	
Ref.	Tamaño
029057	Grande
029410	Pequeño



PUNTEROS	
Ref.	Tamaño
029304	Grueso
029305	Normal
029306	Pequeño
020060	Cantero

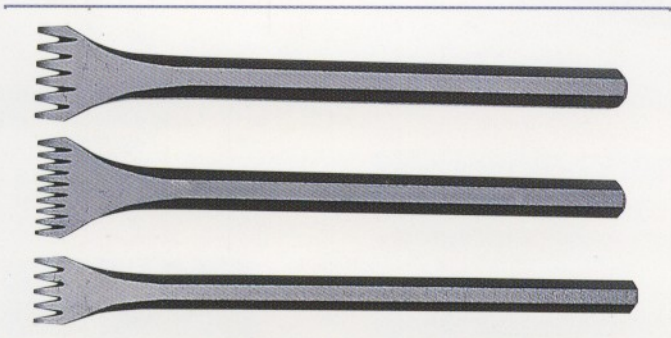

GRADINAS / Distintas medidas	
Ref.	Medida
029876	16, 20, 32 mm

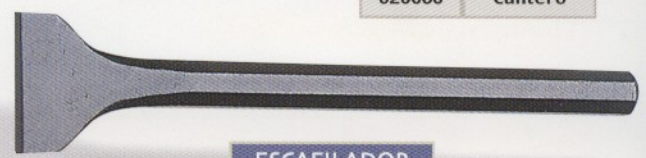

ESCAFILADOR	
Ref.	Medida
029877	40 mm

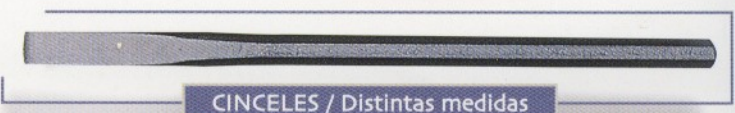

CINCELES / Distintas medidas	
Ref.	Ref.
029874	4, 6, 8, 10, 12, 14, 16, 20 mm

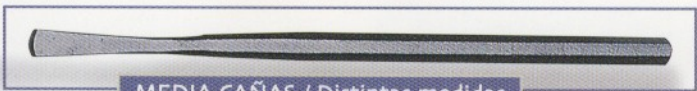

MEDIA CAÑAS / Distintas medidas	
Ref.	Medida
029875	8, 12 mm

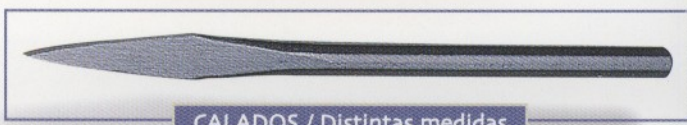

CALADOS / Distintas medidas	
Ref.	Medida
029873	4, 6 mm



**UÑETAS**

Ref.	Boca	Plaquita de M. Duro	Longitud
0242	20 m/m	20 X 20 X 5	200 m/m
0241	18 m/m	18 X 20 X 5	200 m/m
0240	15 m/m	15 X 12 X 5	180 m/m
0239	12 m/m	12 X 12 X 5	140 m/m
0238	10 m/m	12 X 12 X 5	140 m/m

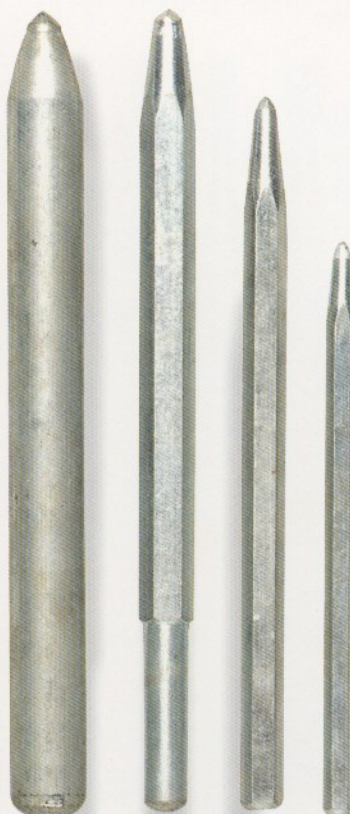
**PUNTEROS**

Ref.	Boca
0255	Grueso de Cantero
0227	Grueso
0226	Normal
0225	Pequeño

**ESCAFILADOR**

Ref.
0259

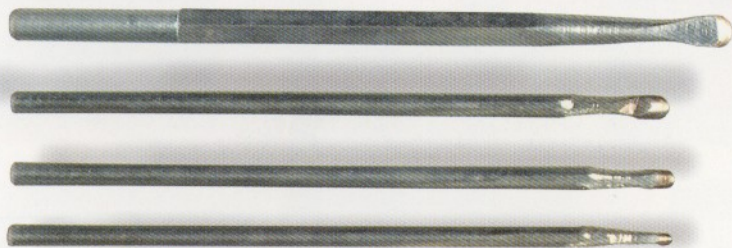
**MEDIACAÑAS**

Ref.	Boca
0256	4 m/m
0257	6 m/m
0258	10 m/m

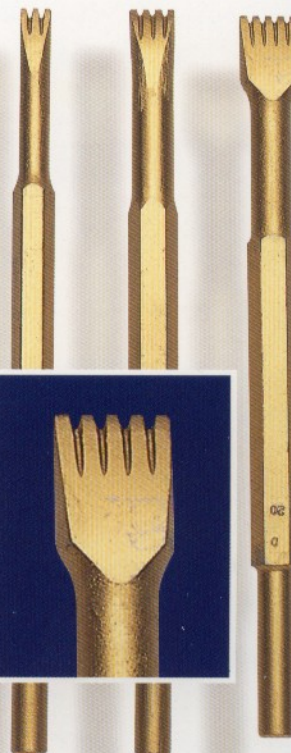
**GRADINAS IT**

Ref.	Boca
029581	10 m/m
029582	15 m/m
029583	20 m/m

**TIRALÍNEAS**

Ref.
0224





CINCELES

Ref.	Boca	Ref.	Boca	Ref.	Boca	Ref.	Boca
0216	4 m/m	0218	8 m/m	0220	12 m/m	0222	16 m/m
0217	6 m/m	0219	10 m/m	0221	14 m/m	0223	20 m/m



MARTILLINAS

Medidas	Dientes	Mango	Rebaje	Long.	Ref.
15 x 15	5 x 5	Cuadrado de 15 mm	50 x 11,5 mm. Ø	160 mm.	029164
12 x 12	4 x 4	Cuadrado de 12 mm	50 x 11,5 mm. Ø	160 mm.	029163
8 mm.	3 x 3	Exagonal de 11 mm	50 x 10,5 mm. Ø	160 mm.	029162
4 mm.	3 x 2	Exagonal de 11 mm	50 x 10,5 mm. Ø	160 mm.	029161
4 mm.	2 x 2	Exagonal de 11 mm	50 x 10,5 mm. Ø	160 mm.	029160



CINCELES DE WIDIA IT

Ref.	Boca	Ref.	Boca	Ref.	Boca	Ref.	Boca
029319	6 m/m	029359	10 m/m	029361	14 m/m	029363	18 m/m
029358	8 m/m	029360	12 m/m	029362	16 m/m	029364	20 m/m

GRADINAS



Ref.	Boca
0246	11 mm.
0247	14 mm.
0248	20 mm.





COMPASES CURVOS

Ref.	Modelo	Ref.	Modelo
029350	200	029354	500
029351	250	029355	600
029352	300	029356	800
029353	400	029357	1000



ESCUADRA

Ref.	Medidas
029878	15 x 10

ESCUADRAS CALIBRADAS

Ref.	Medidas
028581	35 X 23
028582	40 X 27
028583	50 X 23
028584	60 X 37
028536	70 X 40

REGLAS MILIMETRADAS DE ACERO INOXIDABLE FLEXIBLE

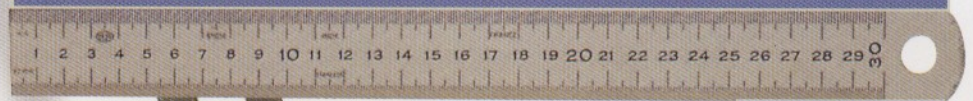

Ref.	Medidas
099641	50 cm.
098565	1 m.
098564	1,5 cm.
099236	1 m. doble grosor



CINTA METRICA ACERO INOXIDABLE

Ref.	Medida
099813	3 m



COMPASES RECTOS

Ref.	Modelo	Ref.	Modelo
029340	200	029343	400
029341	250	029344	500
029342	300	029345	600

Consultar otras medidas



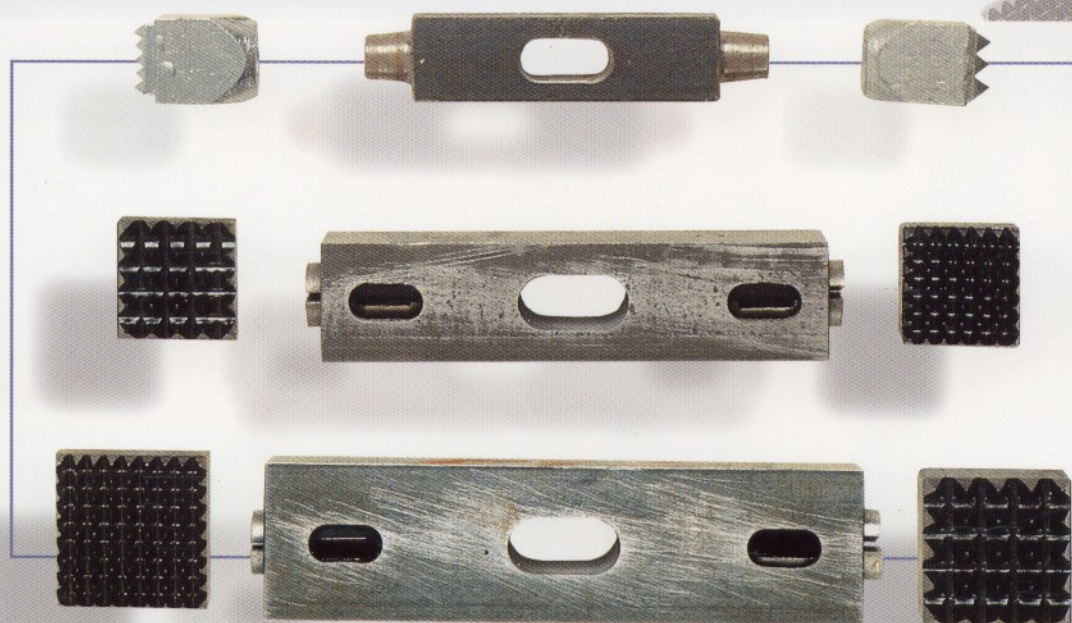

BUJARDAS	
Ref.	Tamaño
118580	Pequeño
118579	Mediano
118587	Grande

BOCAS DE BUJARDA		
Ref.	Dientes	Medida
118626	5 x 5	45 x 45
	7 x 7	
	9 x 9	
118627	5 x 5	35 x 35
	7 x 7	
	9 x 9	
	11 x 11	



MACETA REDONDA CON MANGO

Ref.	PESO
029053	1 kg
029054	1,250



MACETA CUADRADA

Ref.	PESO
029100	1 kg
029102	1,5 kg



MACETA REDONDA CON MANGO

Ref.	PESO
029214	0,5 kg



MAQUINA DE SACAR PUNTOS

Ref.
148628



MANGOS DE MADERA

Ref.
029097



MACETA OCHAVADA

Ref.	PESO
029879	5 kg



	Nº	REF.	Medida		Nº	REF.	REF.
	1	3711	2 m/m		19	3702	8 m/m
	2	3741	3 m/m		20	3707	10 m/m
	3	3739	10 m/m		21	3704	22 m/m
	4	3727	10 m/m		22	3707	6 m/m
	5	3723	6 m/m		23	3706	13 m/m
	6	3722	6 m/m		24	3701	6 m/m
	7	3721	5 m/m		25	3703	16 m/m
	8	3719	6 m/m		26	3705	5 m/m
	9	3715	3 m/m		27	3705	10 m/m
	10	3706	5 m/m		28	3739	6 m/m
	11	3709	3 m/m		29	3701	13 m/m
	12	3709	8 m/m		30	3706	20 m/m
	13	3709	13 m/m		31	3703	6 m/m
	14	3711	3 m/m		32	3704	16 m/m
	15	3708	6 m/m		33	3703	13 m/m
	16	3710	2 m/m		34	3704	8 m/m
	17	3710	5 m/m		35	3702	10 m/m
	18	3713	6 m/m		36	3701	20 m/m





ESPATULINES DE BARRO

Ref.  
029015

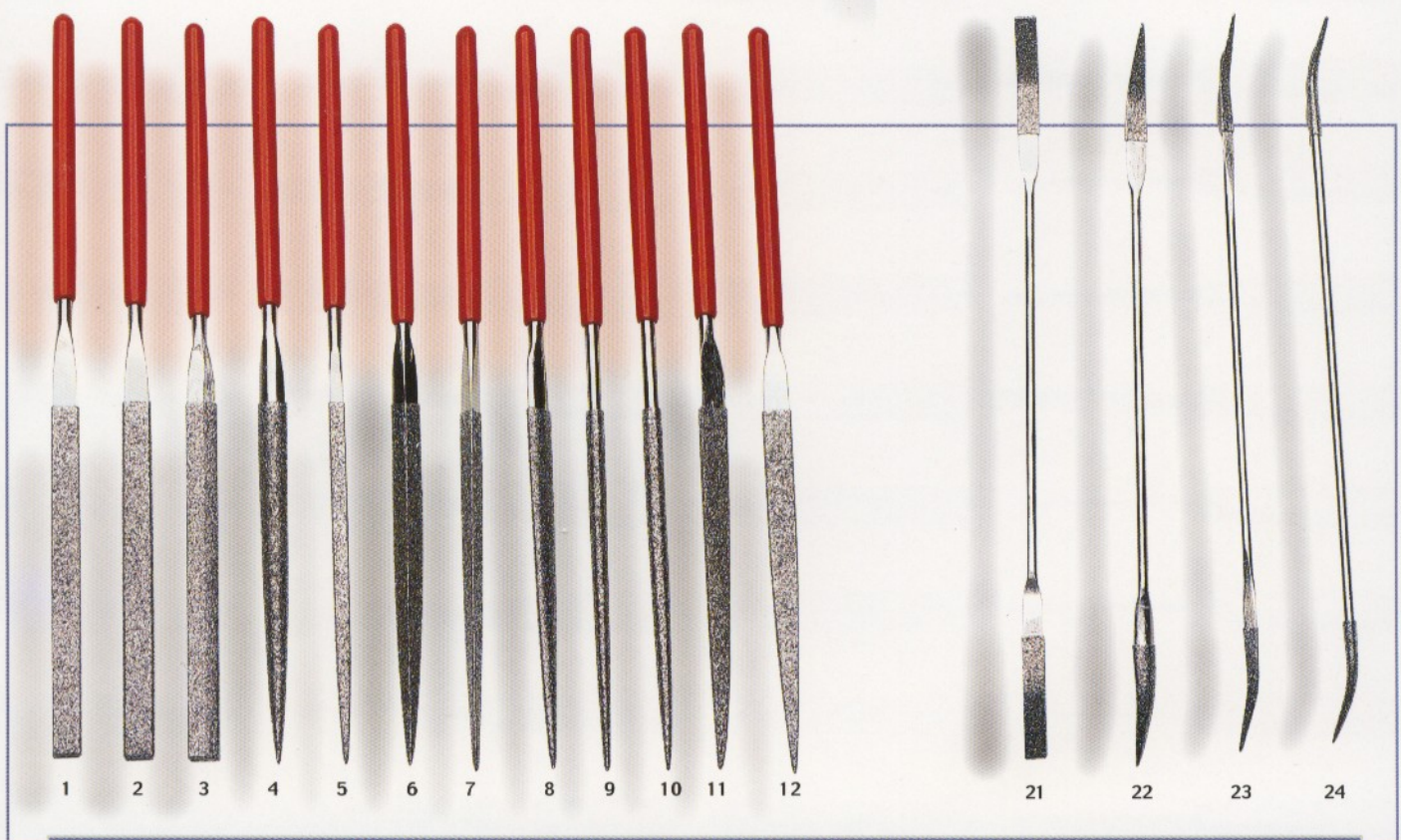

LIMAS DE DIAMANTE ELECTRODEPOSITADO PARA MARMOL

Ref.  
239802

Ref.  
239803





Ref.  
029329



Ref.  
029330

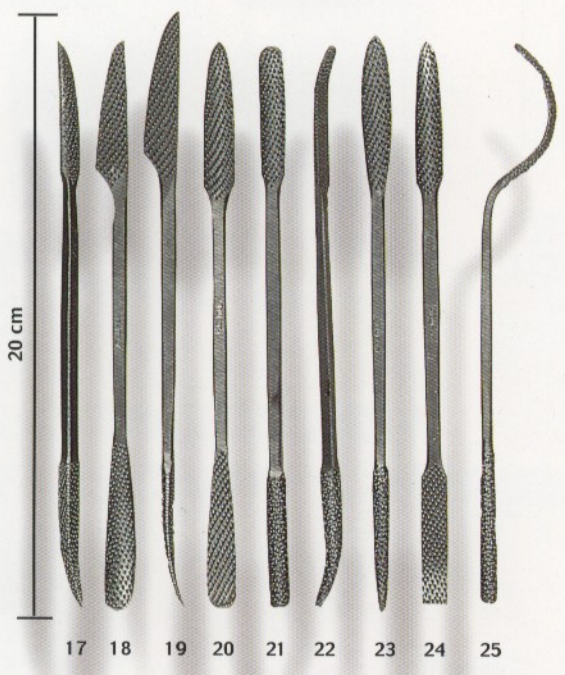

Ref.  
029331

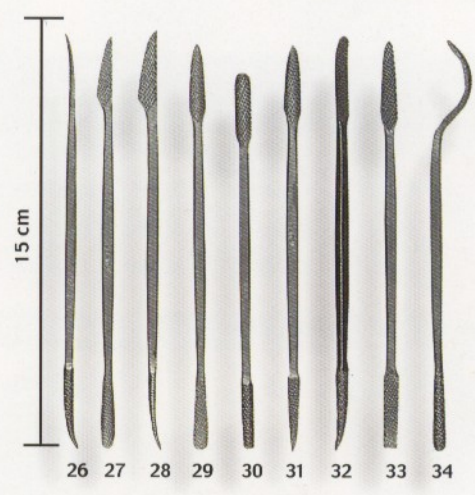

Ref.  
029332



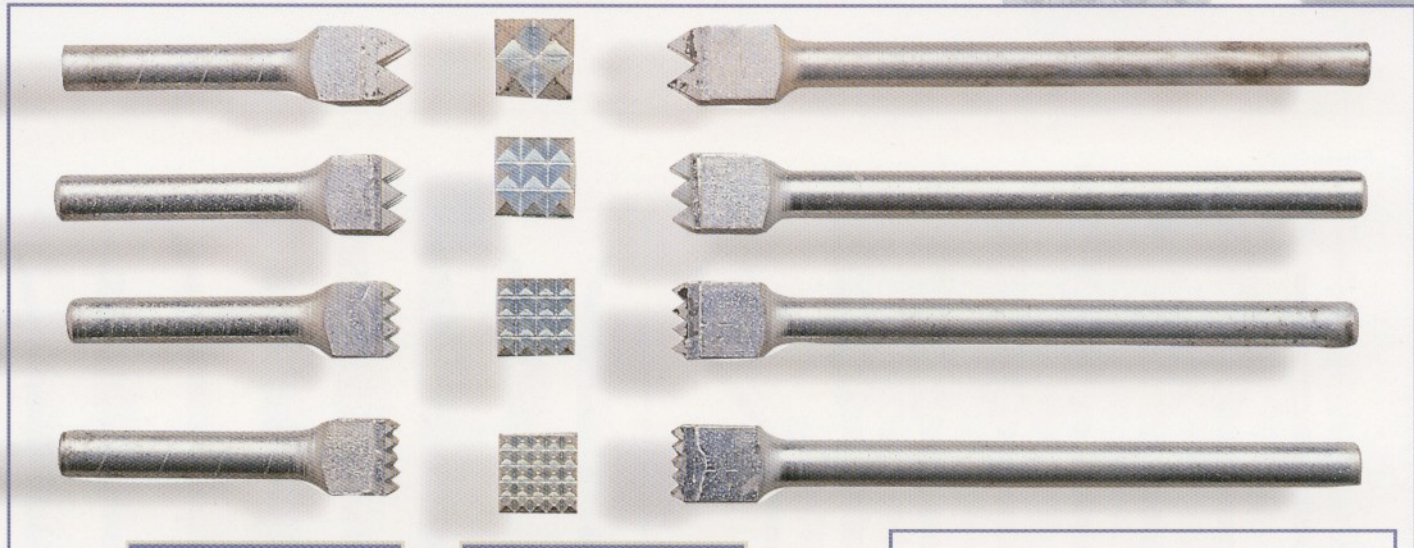

### BAILARINES DE MANO MANGO CORTO

Ref.	Dientes
0229	2 x 2
0230	3 x 3
0231	4 x 4
0232	5 x 5

### BAILARINES DE MANO MANGO LARGO

Ref.	Dientes
0237	2 x 2
0252	3 x 3
0253	4 x 4
0254	5 x 5



### BAILARINES IT

Ref.	Dientes	Medida
028577	4 x 4	30 x 30
028578	3 x 3	30 x 30
029577	3 x 3	25 x 25

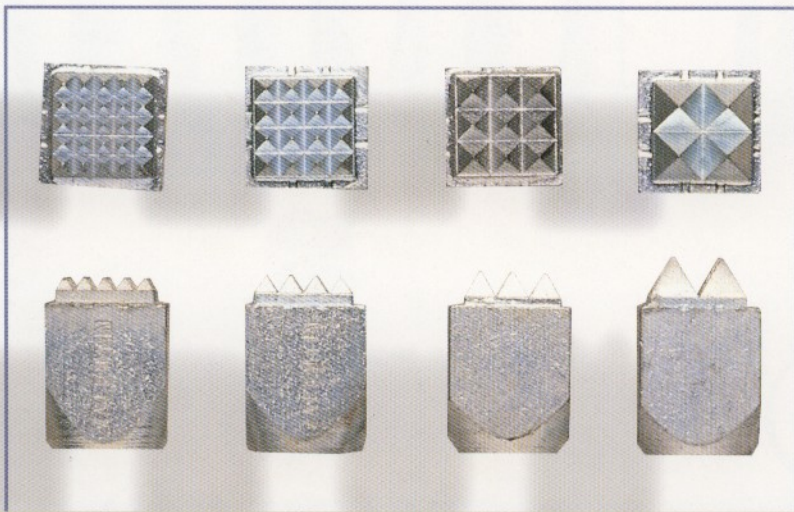

### BAILARINES DE MAQUINA

Ref.	Dientes	Material	Observaciones	Longitud
0233	2 x 2	Cuadrado de 25 mm	Cono para mango	35 mm
0234	3 x 3	Cuadrado de 25 mm	Cono para mango	35 mm
0235	4 x 4	Cuadrado de 25 mm	Cono para mango	35 mm
0236	5 x 5	Cuadrado de 25 mm	Cono para mango	35 mm

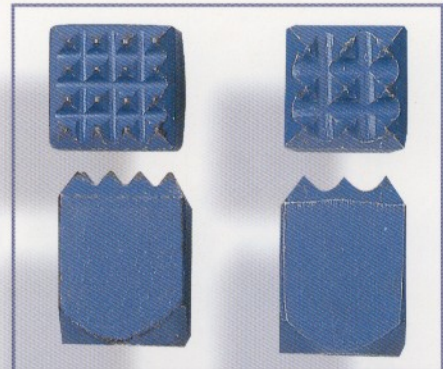

### BAILARINES DE MAQUINA IT

Ref.	Dientes	Eje	Medida
028575	3 x 3	12	25 x 25
028576	4 x 4	12	25 x 25

También disponibles con mango corto

### PLATOS DE ABUJARDAR

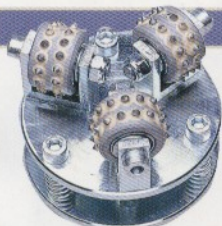

Ref.	Ø
109557	100
109617	130

Para radial con regulación de revoluciones



Ref.	Ø
109973	100

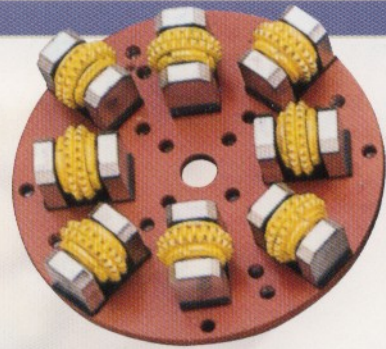

Para maquinaria adaptable  
Consultar otros modelos

Ref.	Varios Ø y varios nº de rullas
109974	



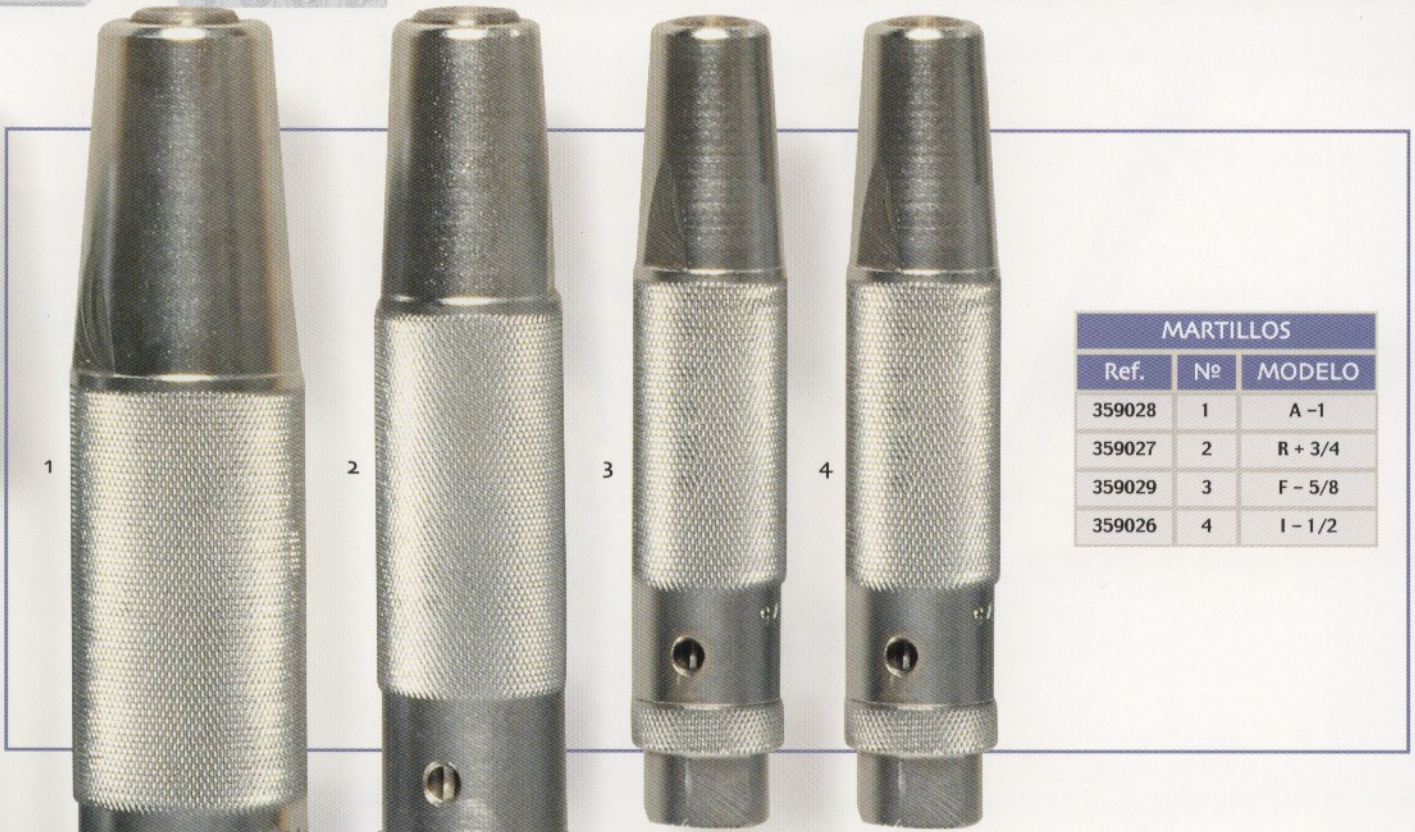

MARTILLOS		
Ref.	Nº	MODELO
359028	1	A-1
359027	2	R + 3/4
359029	3	F - 5/8
359026	4	I - 1/2

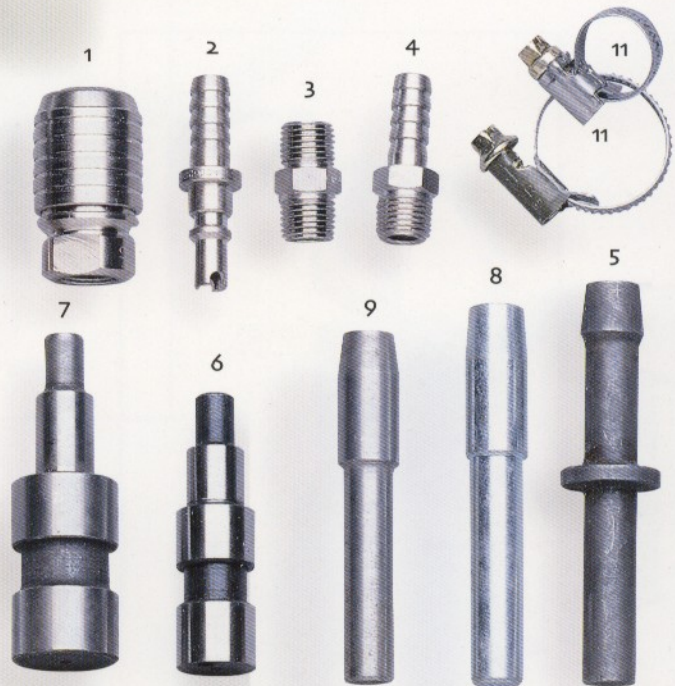

MANGUERA 8 X 16

Ref.  
15M8

MANGUERA 19

Ref.  
3/4

## ACCESORIOS

Ref.	Nº	Descripción
089033	1	Enchufe rápido CD-25
089034	2	Acoplamiento ACD-25 E
089041	3	Adaptador AD-2M-E
089042	4	Macho-Macho AD-2M-2M
358571	6,7	Pistón para martillo
088569	5,8,9	Porta bujardas
15AF816	11	Abrazaderas
088590	10	grifo 2 salidas



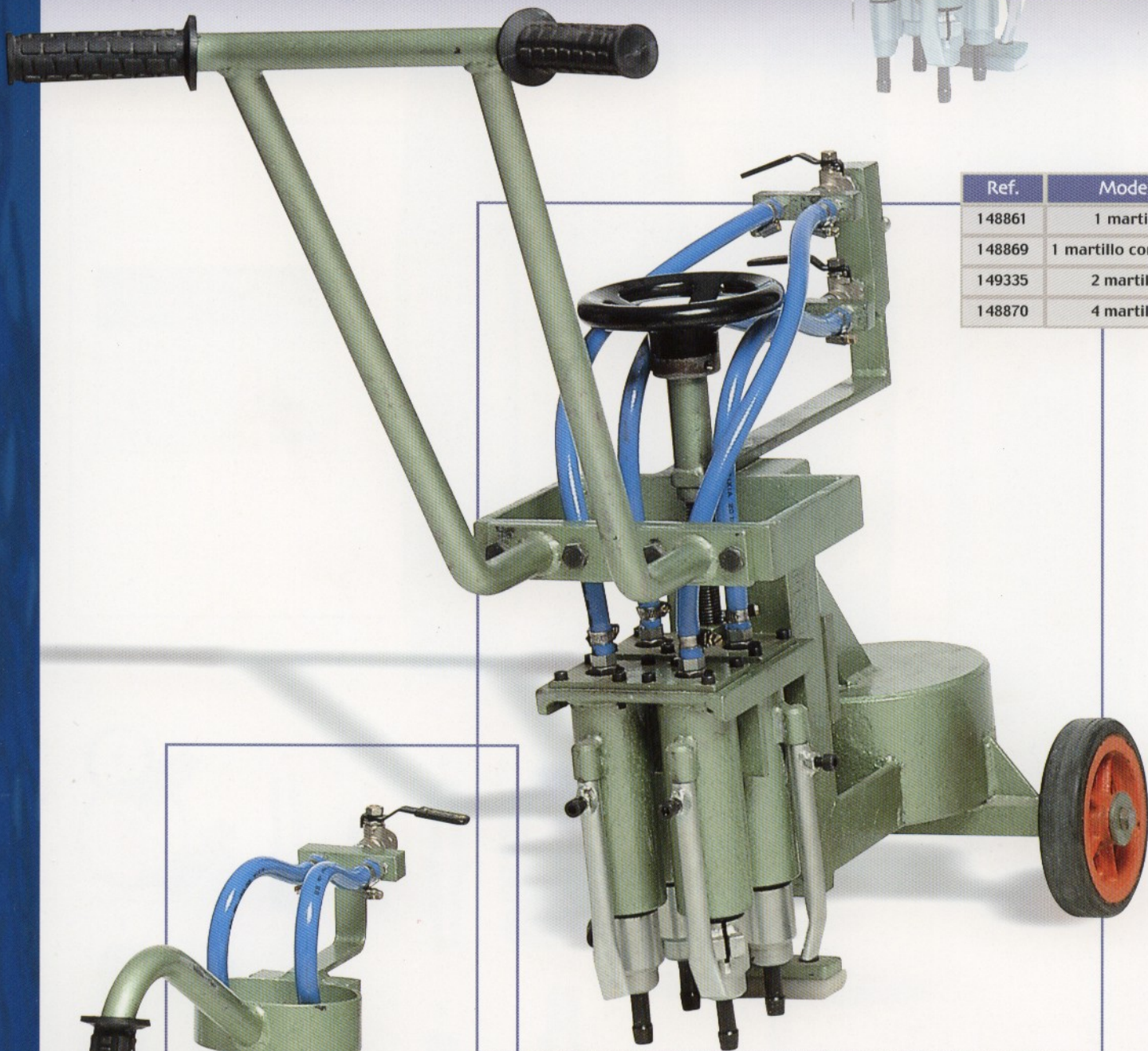

Ref.	Modelo
148861	1 martillo
148869	1 martillo con rodillo
149335	2 martillos
148870	4 martillos

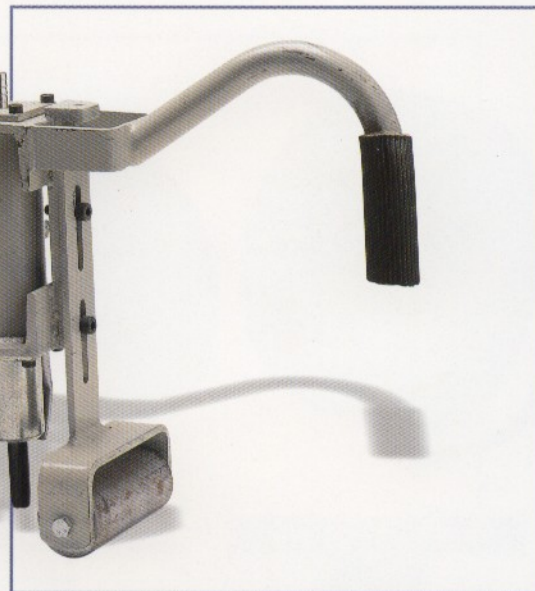





**Atlas Copco**

**EQUIPOS Y  
REPUESTOS**



**BARRAS DE ACERO**

Ref.	Medida
020049	1m - 1,5m

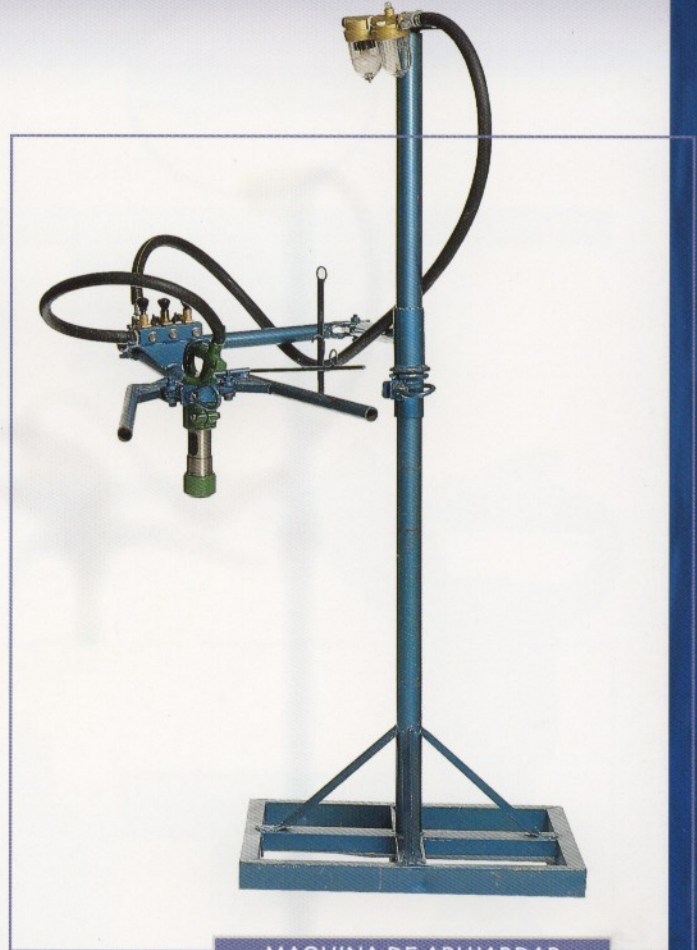

**MAQUINA DE ABUJARDAR**

Ref.

148868

**BAILARINES PL-5**

Ref.	Dientes
022466	2 x 2
029946	3 x 3
023774	4 x 4
021621	5 x 5

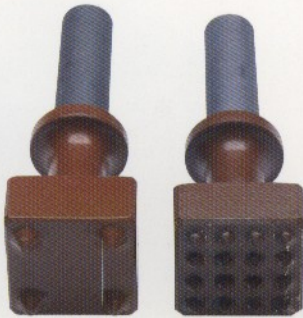

**PUNTERO CUÑERO**

Ref.

158632



**BOCA RAYADOR**

Ref.

118625



**MARTILLO  
PERFORADOR  
Modelo PL-5**

Ref.

168661



**BARRENA S**

Ref.	Boca	Largo
119470	18, 21, 24, 30, 30	250, 250, 300, 300, 600





BARRENAS PARA EXTRACCION DE PIEDRA EN CANTERA

largos
80, 160, 240, 320, 400, 480, 560, 640
Bocas
34, 33, 32, 31, 30, 29, 28, 27, de rayar

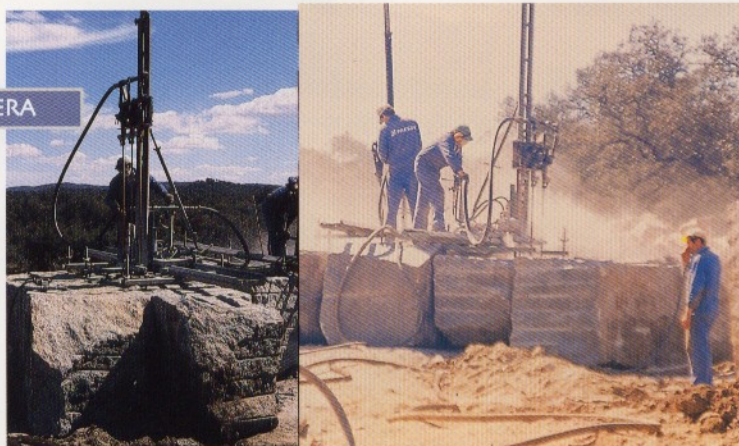

MARTILLO NEUMATICO CUÑERO T-79

Ref.
158639



BOCA BUJARDA

Ref.	Dientes
118607	2 x 2
118608	3 x 3
118609	4 x 4
118610	5 x 5

BOCA TRINCHANTE

Ref.
118629



MUELAS DE AFILAR

Widia	De vaso	Acero
100 x 50 x 20	100 x 50 x 20	150 x 20 x 20
200 x 20 x 20	150 x 50 x 20	150 x 25 x 20
150 x 20 x 20		200 x 25 x 20
200 x 8 x 20		
200 x 10 x 20		



DISCO ORGANICO PARA PIEDRA Y ACERO

Ref.	Medidas
040091	115 x 3 x 22
040092	178 x 3 x 22
040093	230 x 3 x 22



Adaptables a las máquinas cortadoras de hilos de las siguientes marcas: PELLGRINI, GRANIROC, TECMOMAC, MICHELETTI, BIDISIPIANTI, GANCHO ETC.



Ref.	Medida
439762	Ø 340 mm



Ref.	Medida
439760	Ø 390 mm



GOMA ACANALADA 13 m.

Ref.

439764



POLEA DE ALUMINIO

Ref.

439978



GOMA PLANA

Ref.

Medida

439763

370 x 40 x 8



Ref.

Medida

439761

Ø 170 mm





TENSOR PARA FLEJE DE ACERO

Ref.  
539158



FLEJADORA FLEJE PLÁSTICO

Ref.  
539253



TENAZA PARA FLEJE DE ACERO

Ref.  
539159

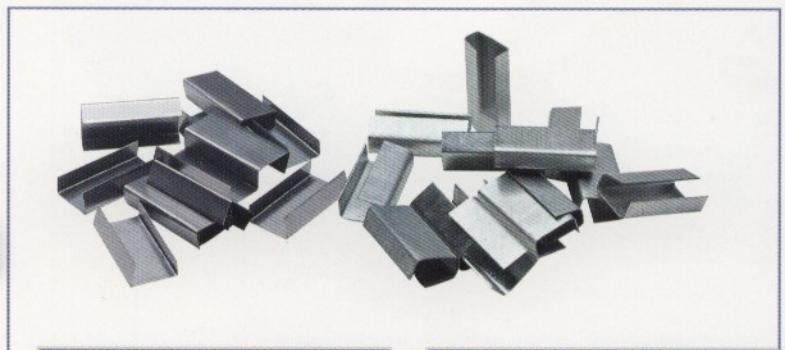

GRAPAS DE FLEJE. ACERO

Ref.  
539284

GRAPAS DE FLEJE. PLASTICO

Ref.  
539255



FLEJE DE PLÁSTICO

Ref.	Medida
539252	13 mm

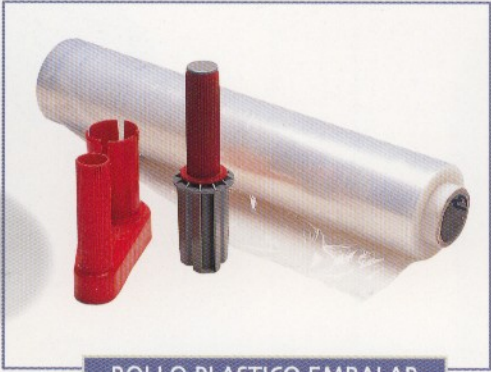

ROLLO PLASTICO EMBALAR

Ref.  
479921



FLEJE DE ACERO

Ref.	Medida
539282	16 mm





UTILES  
DIAMANTADOS



## GRANITO



CANTO PILASTRA		
Ref.	Medida	Grosor
239963	300	12, 15, 20

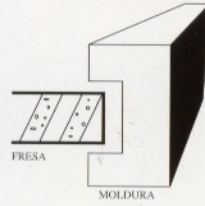

## MARMOL



CANTO PILASTRA		
Ref.	Medida	Grosor
239971	300	12, 15, 20

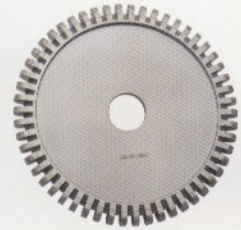

MEDIACAÑA COMPLETA		
Ref.	Medida	Grosor
239958	300	12, 25

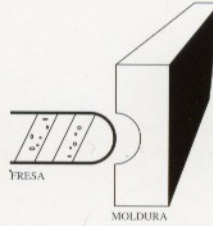

MEDIACAÑA COMPLETA		
Ref.	Medida	Grosor
239966	300	15, 25

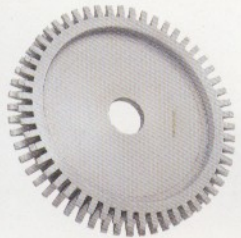

CANTO REDONDO		
Ref.	Medida	Grosor
239959	300	22, 32

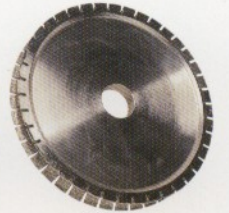
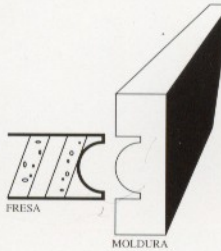

CANTO REDONDO		
Ref.	Medida	Grosor
239967	300	22, 32

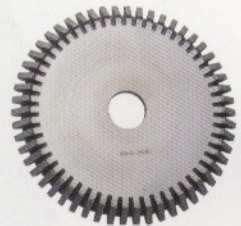

BISEL		
Ref.	Medida	Grosor
239962	300	20, 30

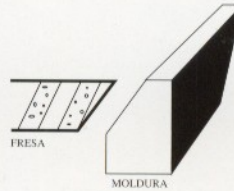

BISEL		
Ref.	Medida	Grosor
239970	300	20, 30

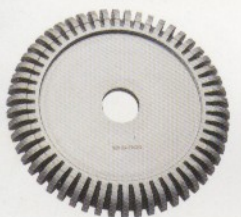

MEDIA CAÑA		
Ref.	Medida	Grosor
239961	300	15, 25

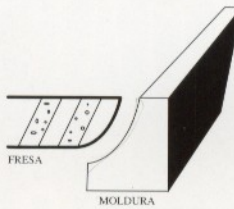

MEDIA CAÑA		
Ref.	Medida	Grosor
239969	300	15, 25



REDONDEADO		
Ref.	Medida	Grosor
239960	300	30, 45

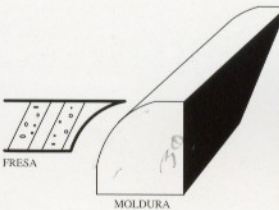

REDONDEADO		
Ref.	Medida	Grosor
239968	300	30, 45

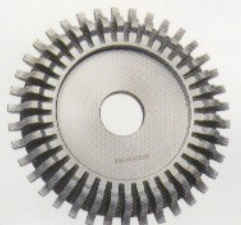

PECHO PALOMA		
Ref.	Medida	Grosor
239964	250	10+10 15+15

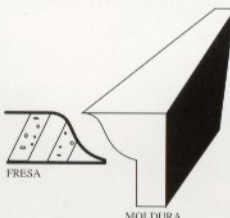

PECHO PALOMA		
Ref.	Medida	Grosor
239972	250	10+10 15+15



**DISCOS PARA  
CORTE DE  
MARMOL,  
GRANITO,  
ARENISCA,  
CALIZA, GRES,  
HORMIGÓN**

**DISCO DE MARMOL**

Ref.	Ø
238746	300, 350, 400, 450, 500, 600, 725, 800

**DISCO DE MARMOL INSONORO**

Ref.	Ø
238797	300, 350, 400, 450, 500, 600, 725, 800

**DISCO GRANITO**

Ref.	Altura	Ø
238753	10 mm	300, 350, 400
238754	15 mm	350, 400, 450, 600, 725, 800

**DISCO GRANITO INSONORO**

Ref.	Altura	Ø
238796	10 mm	300, 350, 400
239690	15 mm	350, 400, 5000, 600, 725, 800





LIJAS PARA MARMOL

Ref.  
238974

LIJAS PARA GRANITO

Ref.  
238842

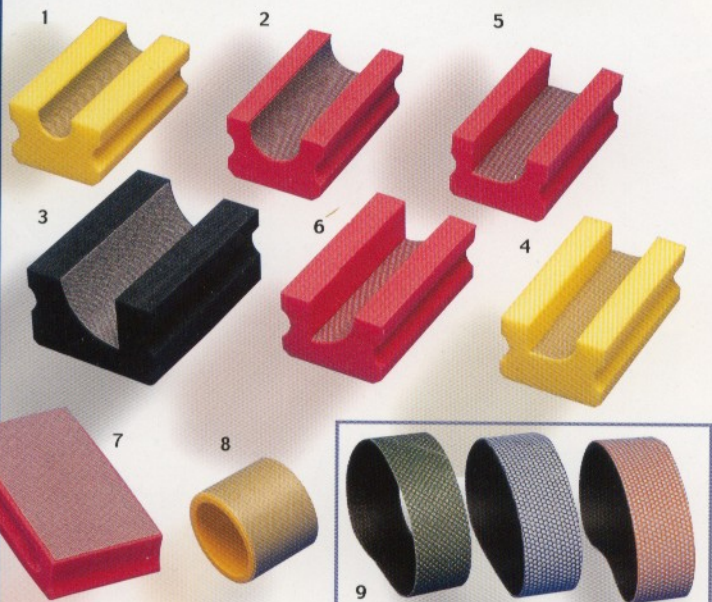

DISTRIBUIDOR



LIJAS DE DIAMANTE PARA GRANITO

GRANO	COLOR
60	Verde
180	Negro
280	Rojo
500	Amarillo
1800	Blanco
2500	Azul

LIJAS DE DIAMANTE PARA MARMOL

GRANO	COLOR
60	Verde
120	Negro
180	Rojo
360	Amarillo
800	Blanco
1500	Azul
14000	Naranja



3M LIJA TRIANGULO

Ref.  
239630

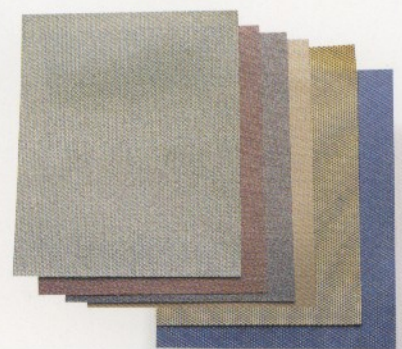

PLIEGOS DE LIJAS DIAMANTADOS

Ref.  
238848

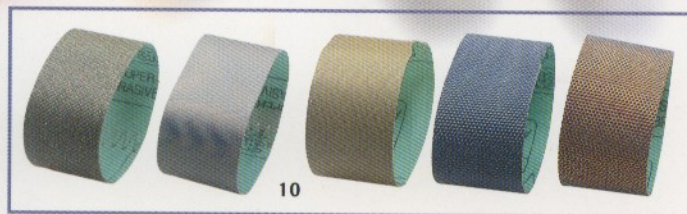

Descripción	Ref.	Grano
1- T.REDONDO 20mm	238821	120,180, 360
2- T.REDONDO 30mm	238824	120, 180, 360
3- MEDIO BAQUETON 30mm	238830	120, 180, 360
4- REDONDEADO 20mm	238815	120, 180, 360
5- REDONDEADO 30mm	238818	120, 180, 360
6- MEDIO BAQUETON 20mm	238827	120, 180, 360
7 - T. LISOS 100 x 55 mm	238833	60, 120, 180, 360
8 - TACO TAMBOR 42 x 50 mm	238839	180, 360
9 - BANDAS 100 x 35 mm	239440	60, 120, 180, 360, 800, 500, 1500, 14000
10- LIJA BANDA 70 x35 mm	239857	60, 120, 180, 360, 500, 800, 1500, 14000
11- LIJA BANDA 75 x35 mm	239940	60, 120, 180, 360, 500, 800, 1500, 14000



TORNILLO ENGANCHE RAPIDO

Ref.  
109888

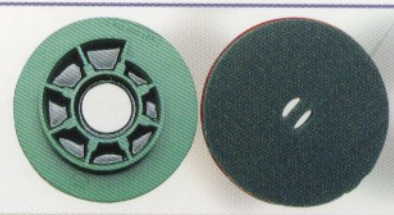

PLATO ENGANCHE RAPIDO CON VELCRO

Ref.	Ø
109868	100



PLATO ENGANCHE RAPIDO PARA BANDAS

Ref.	Ø
109886	75 - 100



3M CORONA DE DIAMANTE RESINA

Ref.	Ø
239530	100
238806	130





CANTERIA H

Ref.

239981



CANTERIA DK

Ref.

239993



CANTERIA LI

Ref.

239992



DISCO 230 DB CANTERIA

Ref.

239994



DISCO 230 GRI CANTERIA

Ref.

238761



DISCO TURBO PASTILLA

Ref.

Ø

238760

300, 230, 180, 125, 115

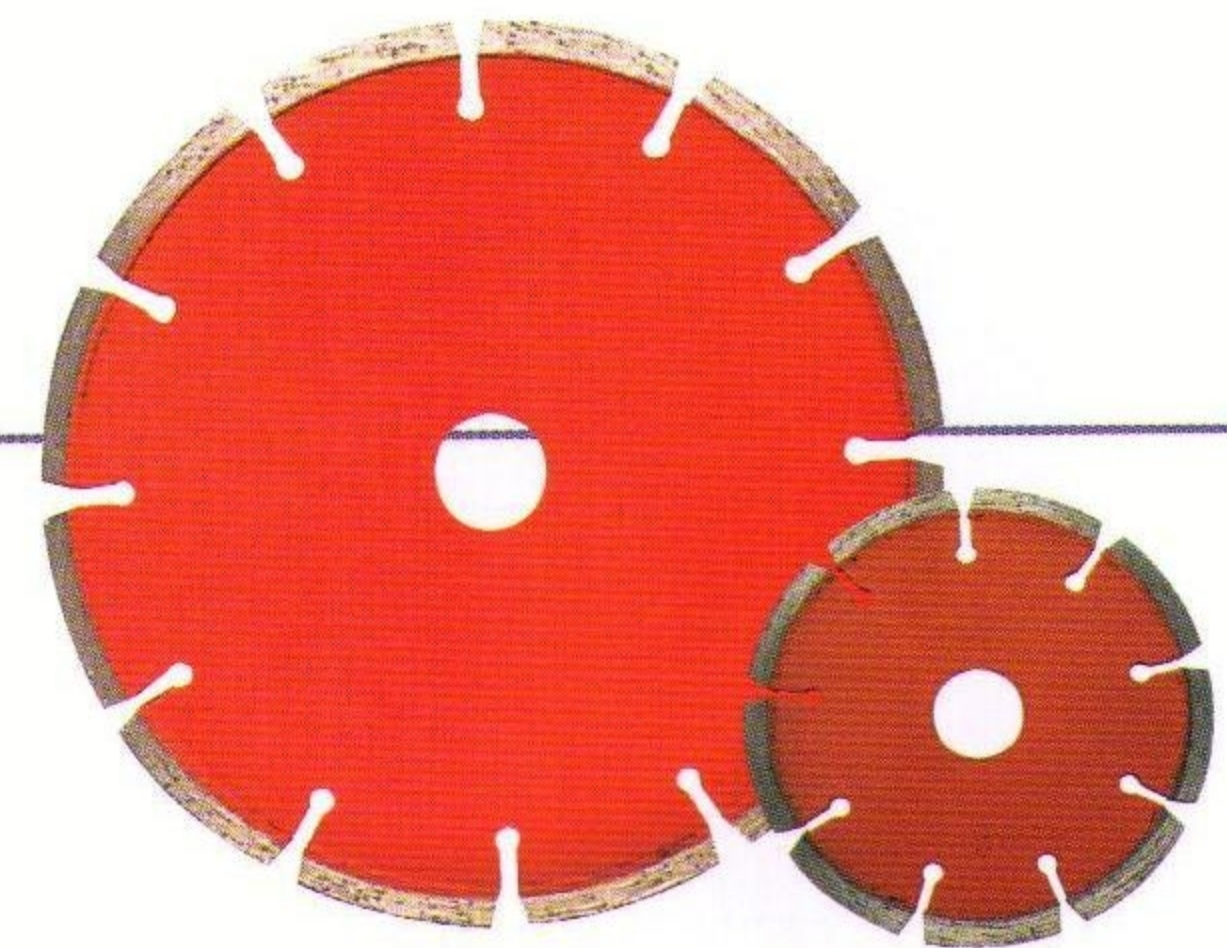

DISCO LASER

Ref.

Ø

238740

115, 180, 200, 230



DISCO 230 DB

Ref.

Ø

239995

180, 200, 230



DISCO 230 TYROLIT

Ref.

Ø

239994

180, 200, 230

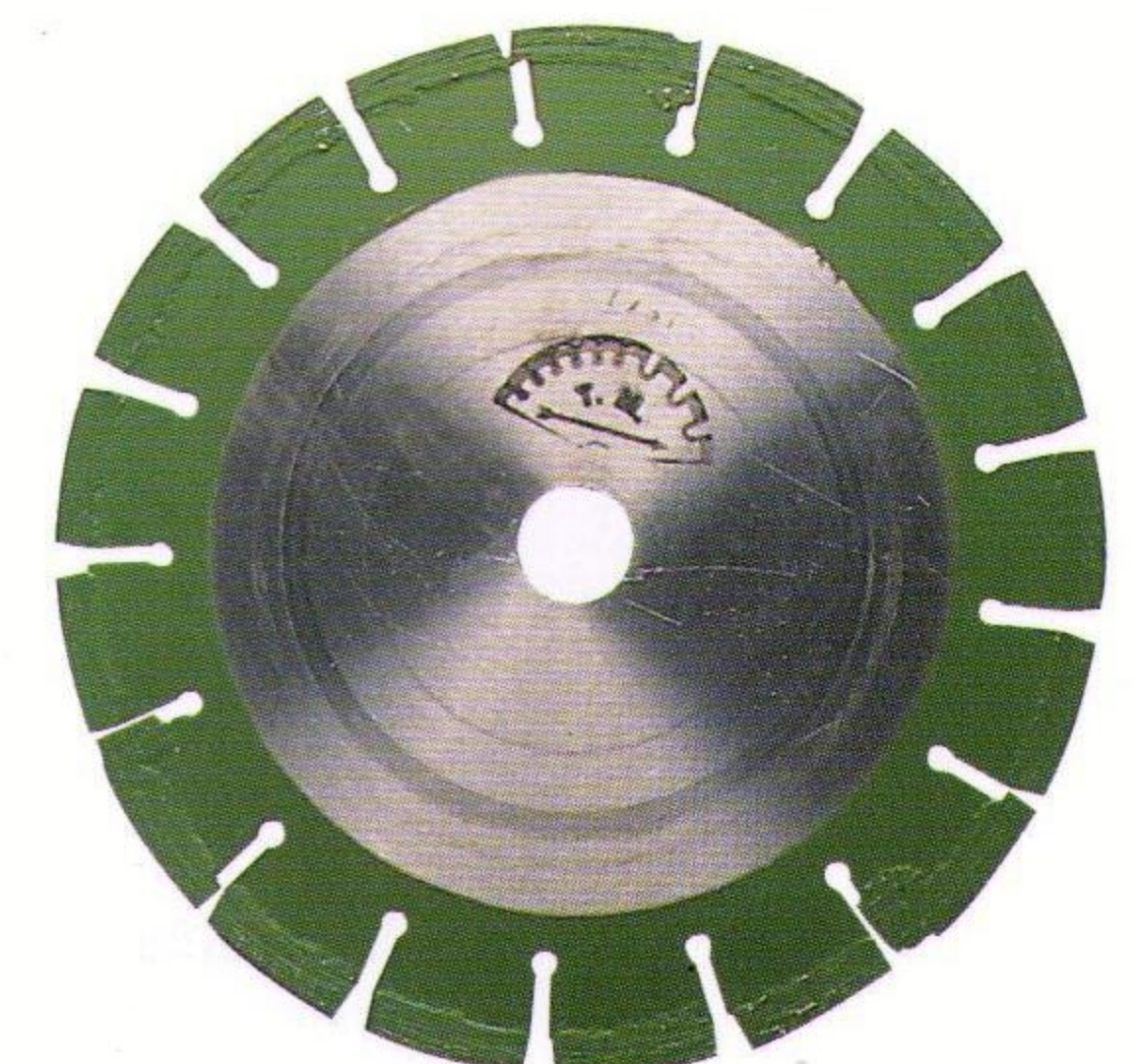

DISCO TM

Ref.

Ø

239998

180, 200, 230



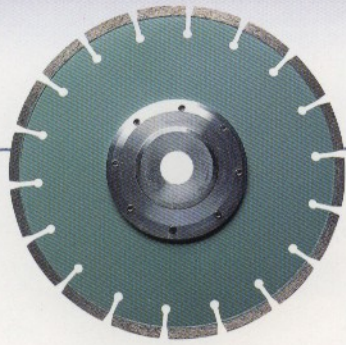

DISCO SEGMENTO CON COPA

Ref.	Ø
239765	110, 125, 230

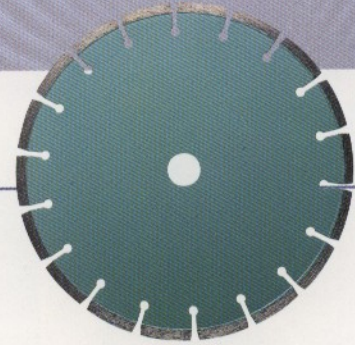

DISCO SEGMENTO LASER

Ref.	Ø
238741	110, 115, 125, 150, 180, 200, 230

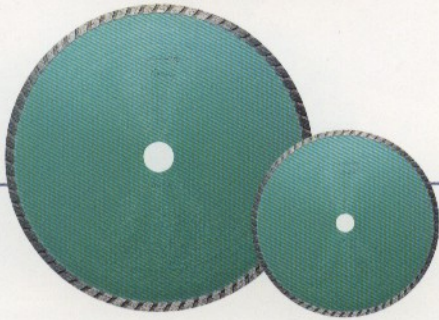

DISCO TURBO

Ref.	Ø
238792	115, 125, 180, 230

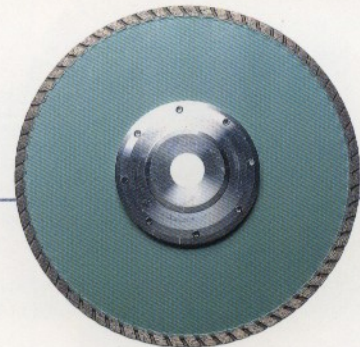

DISCO TURBO CON COPA

Ref.	Ø
239049	110, 125, 230

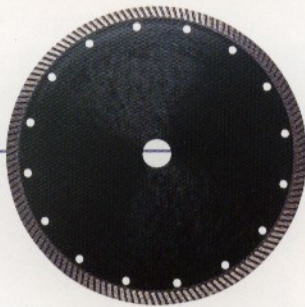

DISCO TURBO

Ref.	Ø
238795	230

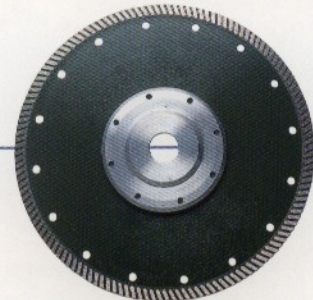

DISCO TURBO CON COPA

Ref.	Ø
238743	230

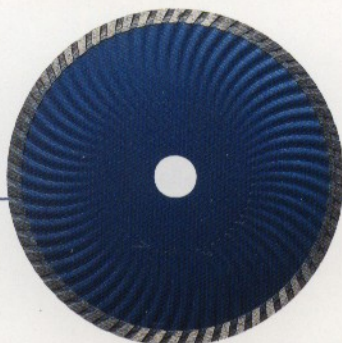

DISCO TURBO REFORZADO

Ref.	Ø
238793	180

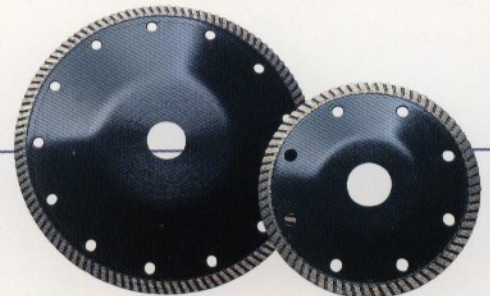

DISCO TURBO BOMBEADO

Ref.	Ø
239541	115, 125, 180





**DISCOS CONCAVOS REFORZADOS**

Ref.	Ø
239024	178, 125



**PIVOTES DE GRANITO**

Ref.
238638

25      26      21

**CORONA DE GRANITO CON ESPÁRAGO 16 Ø**

Ref.
238638

**DISCO DE CORTE Y DESBASTE DE GRANITO**

Ref.
238638

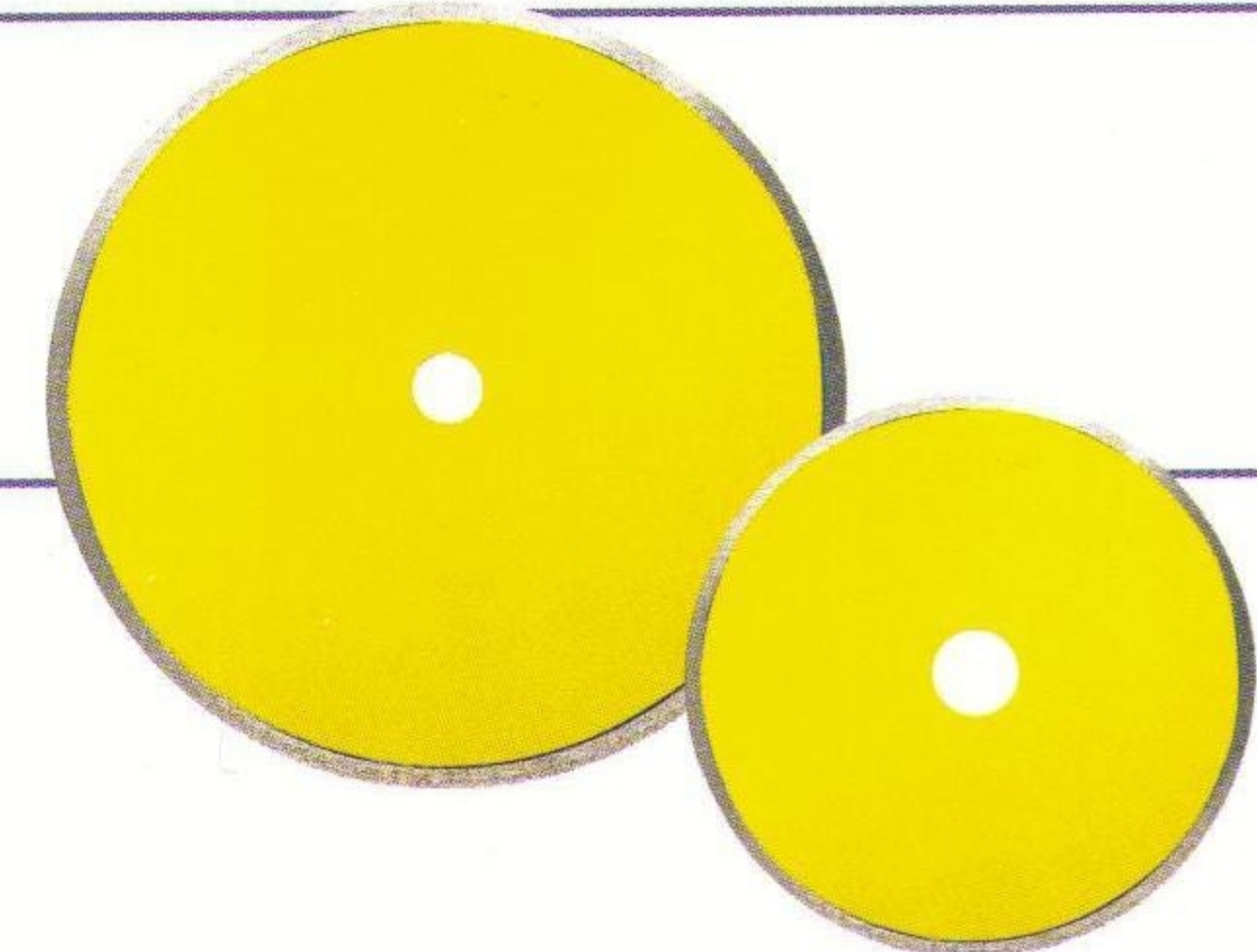

**DISCO CONTINUO PARA CERAMICA**

Ref.	Ø
239900	110, 125, 180, 230, 300



**DISCO SINTERIZADO PARA CERAMICA**

Ref.	Ø
239898	110, 125



**DISCO CONTINUO PARA GRES**

Ref.	Ø
239905	110, 125, 180, 230, 300



**FRESA CANTO PILASTRA**

Ref.	Ø	Grosor
239496	115	7 mm
239497	115	10 mm



**DISCO GRANITO CON ESPARRAGO**

Ref.	Ø
239623	33
239624	41
239625	47 Turbo
239626	51
238776	70



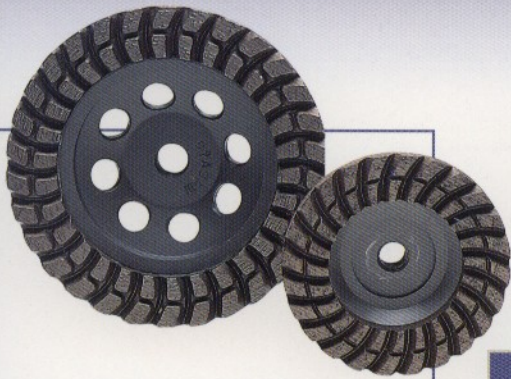

CORONA DE DESBASTE

Ref.	Ø
238786	100
238814	125



MUELA DE DESBASTE CONCAVA

Ref.	Ø
238876	100

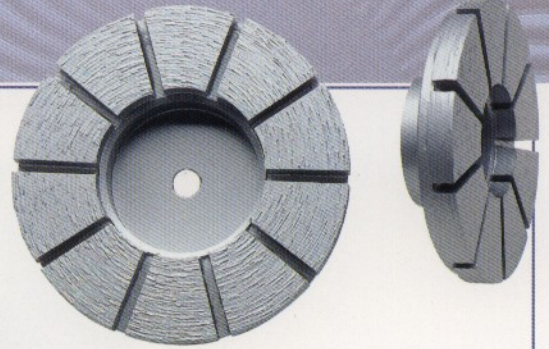

CORONA DE DESBASTE PARA PULICANTOS

Ref.	Ø
239812	100, 125

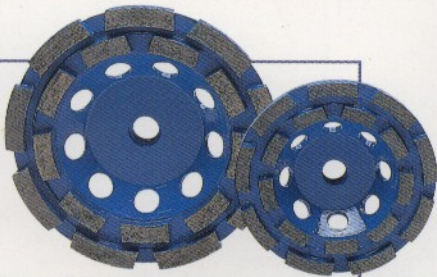

CORONA DE DESBASTE DOBLE SEGMENTO

Ref.	Ø
239584	115
239585	125

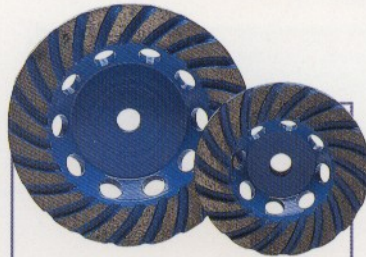

CORONA DE DESBASTE

Ref.	Ø
239979	100
239980	125



CORONA DESBASTE CON SEGMENTOS

Ref.	Ø
238787	130

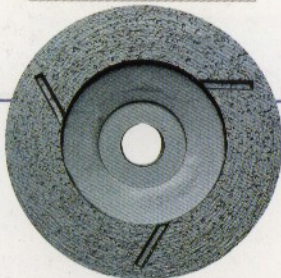

CORONA DE DESBASTE CON AGUA

Ref.	Ø	Granos
238701	130	30/40, 40/50, 60/80, 80/100

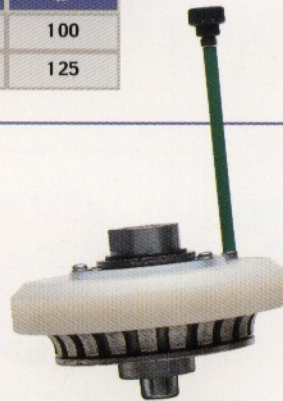

FRESAS PARA MOLDURAS PARA RADIALES

Ref.	Radio	Ø
239930	10 - 15 - 20 - 25	100 - 125

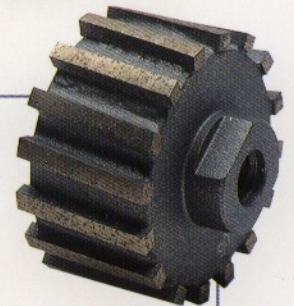

CORONA DE VASO

Ref.	Ø
239469	Varios



BROCAS GRANITO AGUA

Ref.	Ø
239460	desde 4mm hasta 20 mm



ADAPTADOR PARA TALADRO

Ref.
188995



BROCAS DE LAVABO

Ref.	Ø
239729	15, 20, 25, 31, 25, 40, 50, 55, 60, 65, 70, 80, 90



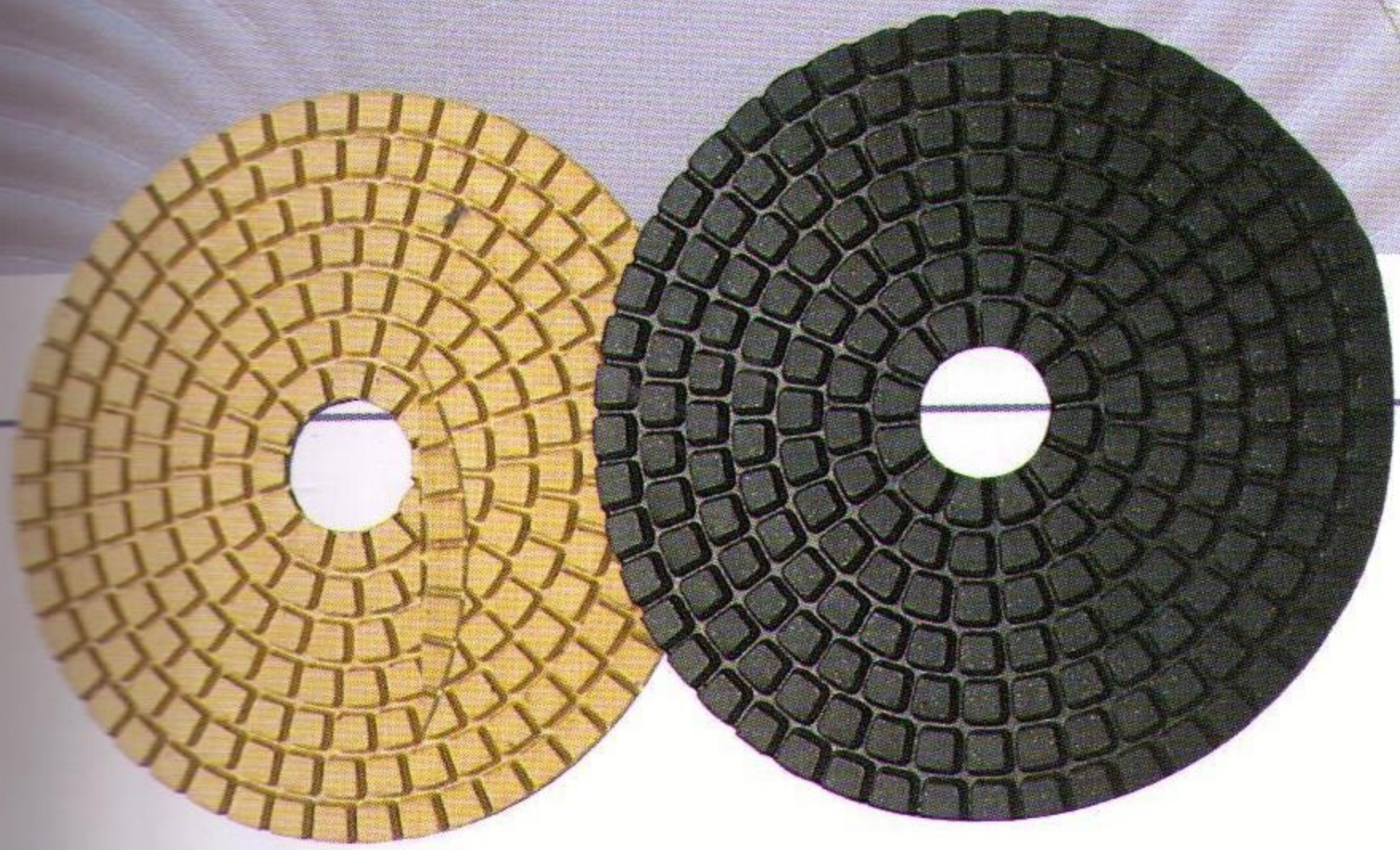

LIJAS VELCRO DE RESINA DE DIAMANTE

Ref.	Ø	Grano
239768	100	50, 100, 200, 400, 800, 1500

LIJAS VELCRO DE RESINA DE DIAMANTE

Ref.	Ø	Grano
239774	100	brillo

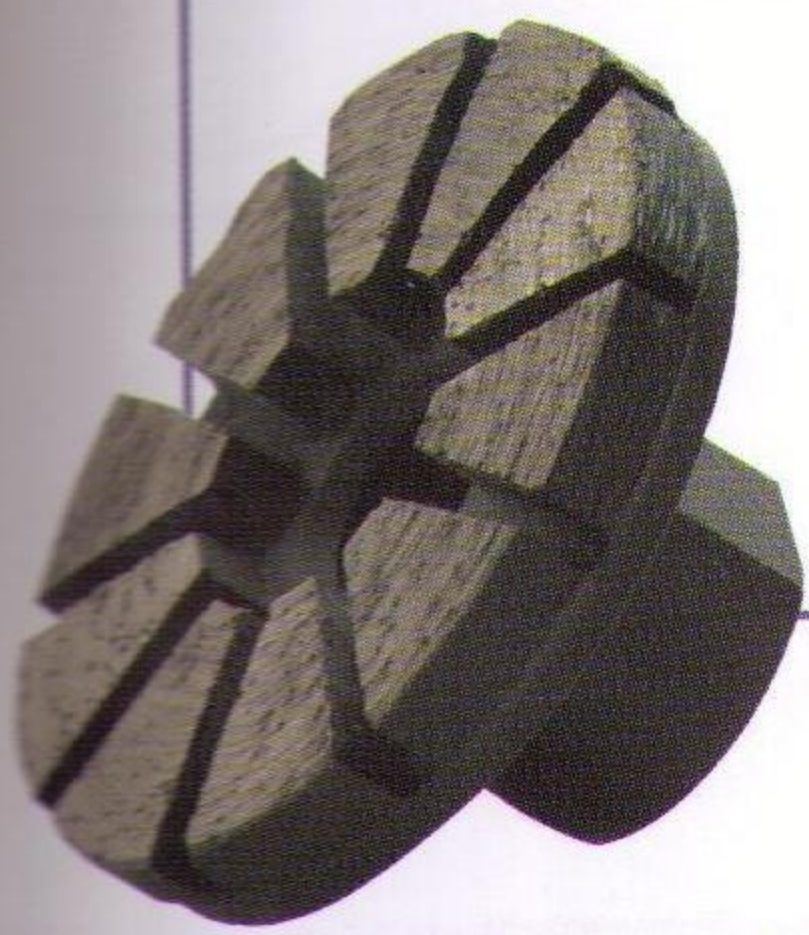
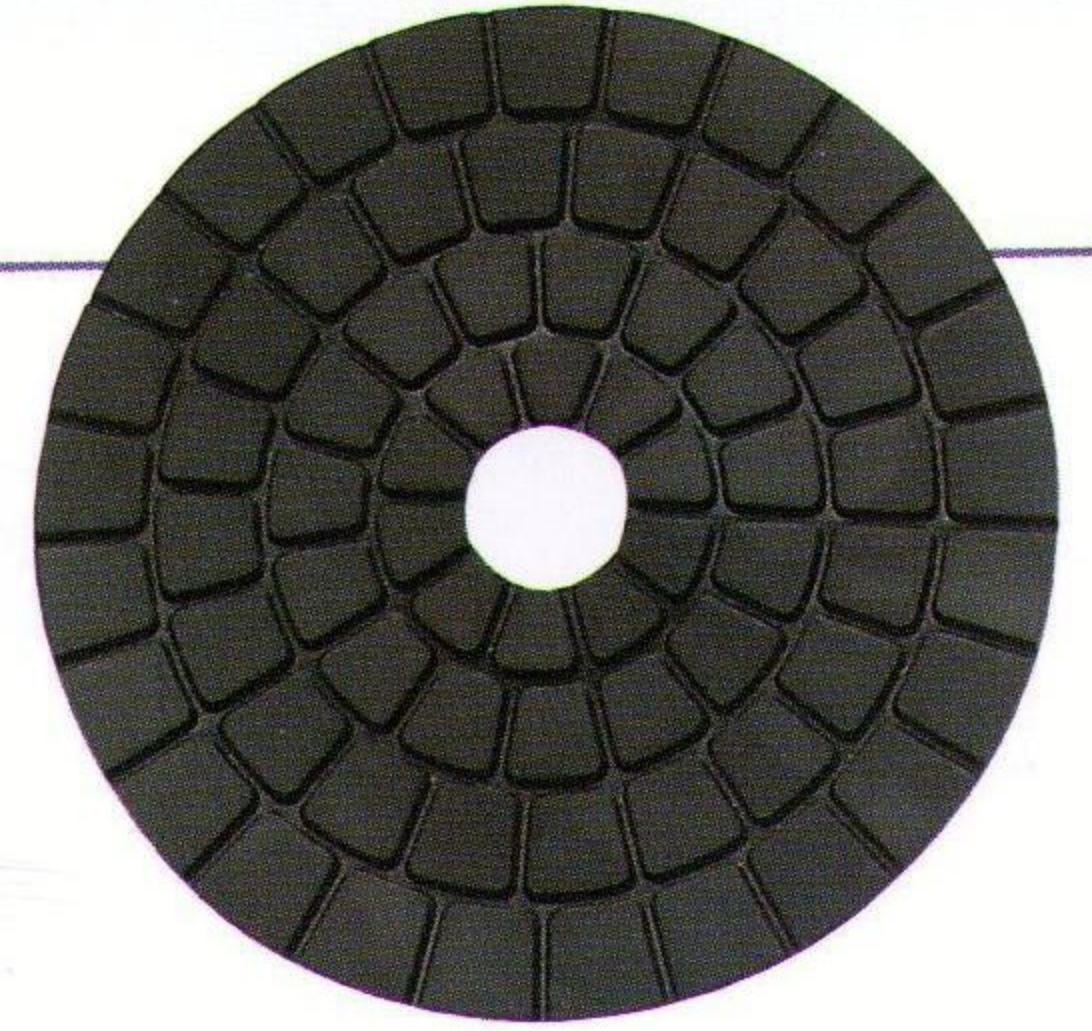

CORONA DE GRANITO PARA DESBASTE

Ref.	Ø
238738	50

PLATO VELCRO ENGANCHE RAPIDO

Ref.	Ø
109868	100

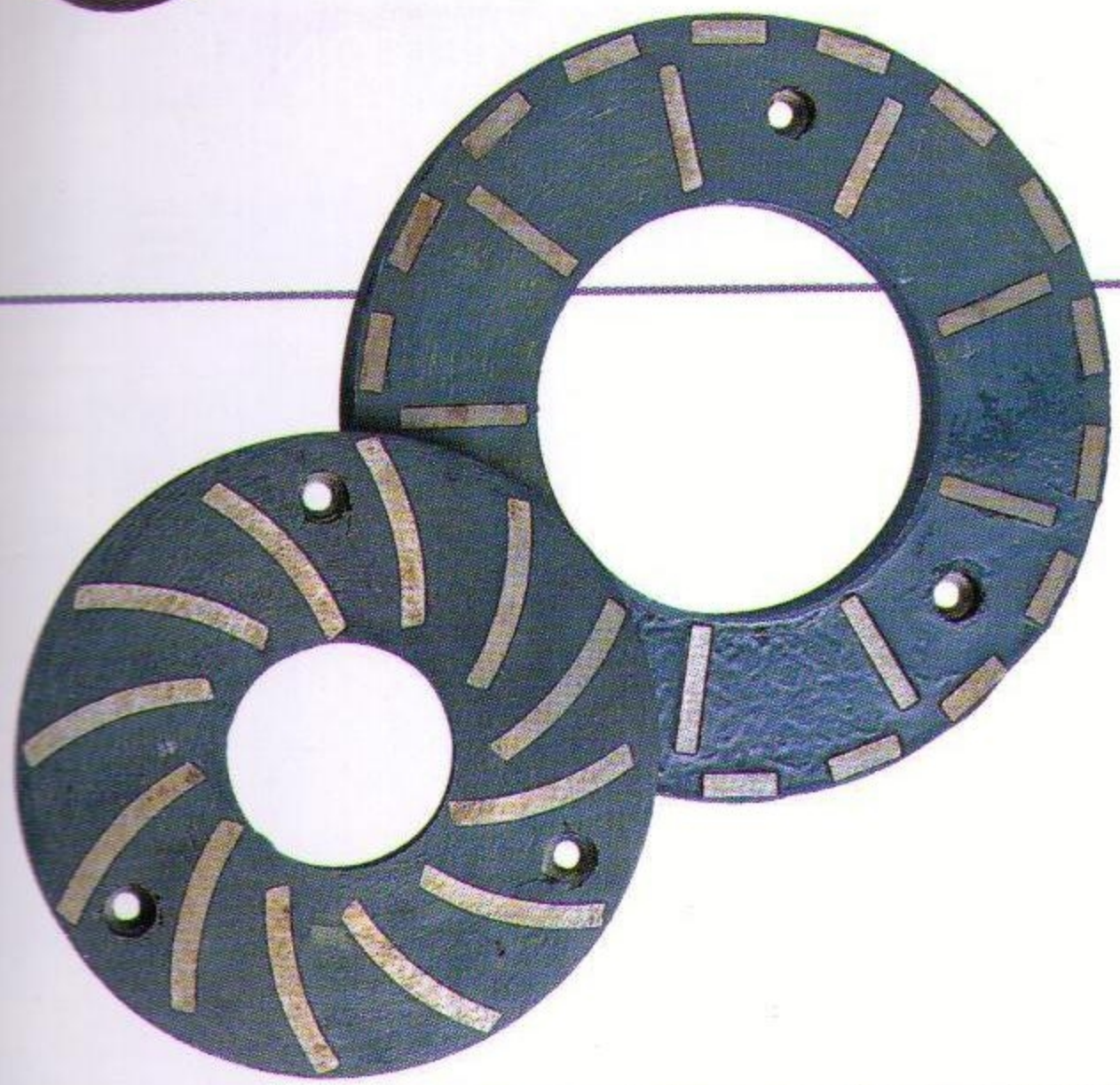
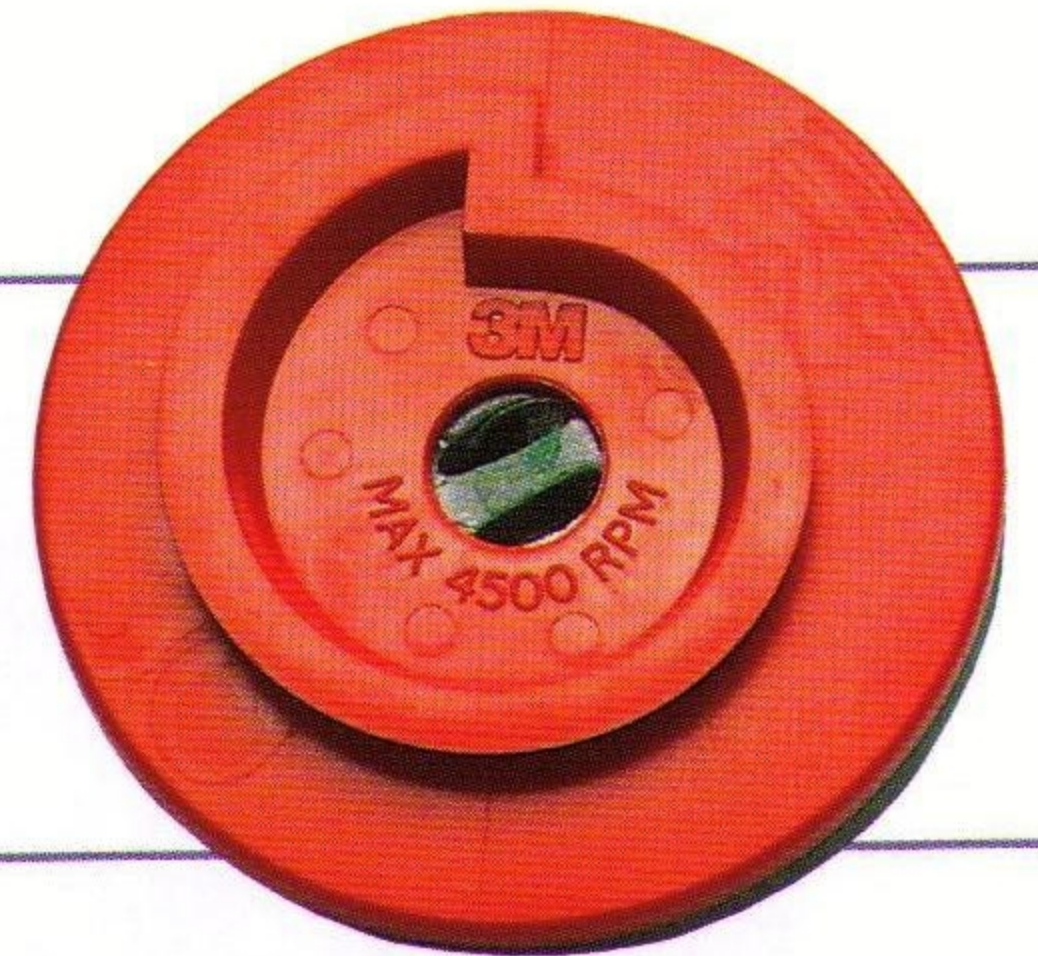

CORONA SEGMENTOS DIAMANTE

Ref.	Ø
239542	200
239543	250



CORONA DE RESINA DE DIAMANTE

Ref.	Granos	Ø
239545	400, 800, 1500, 3000	200

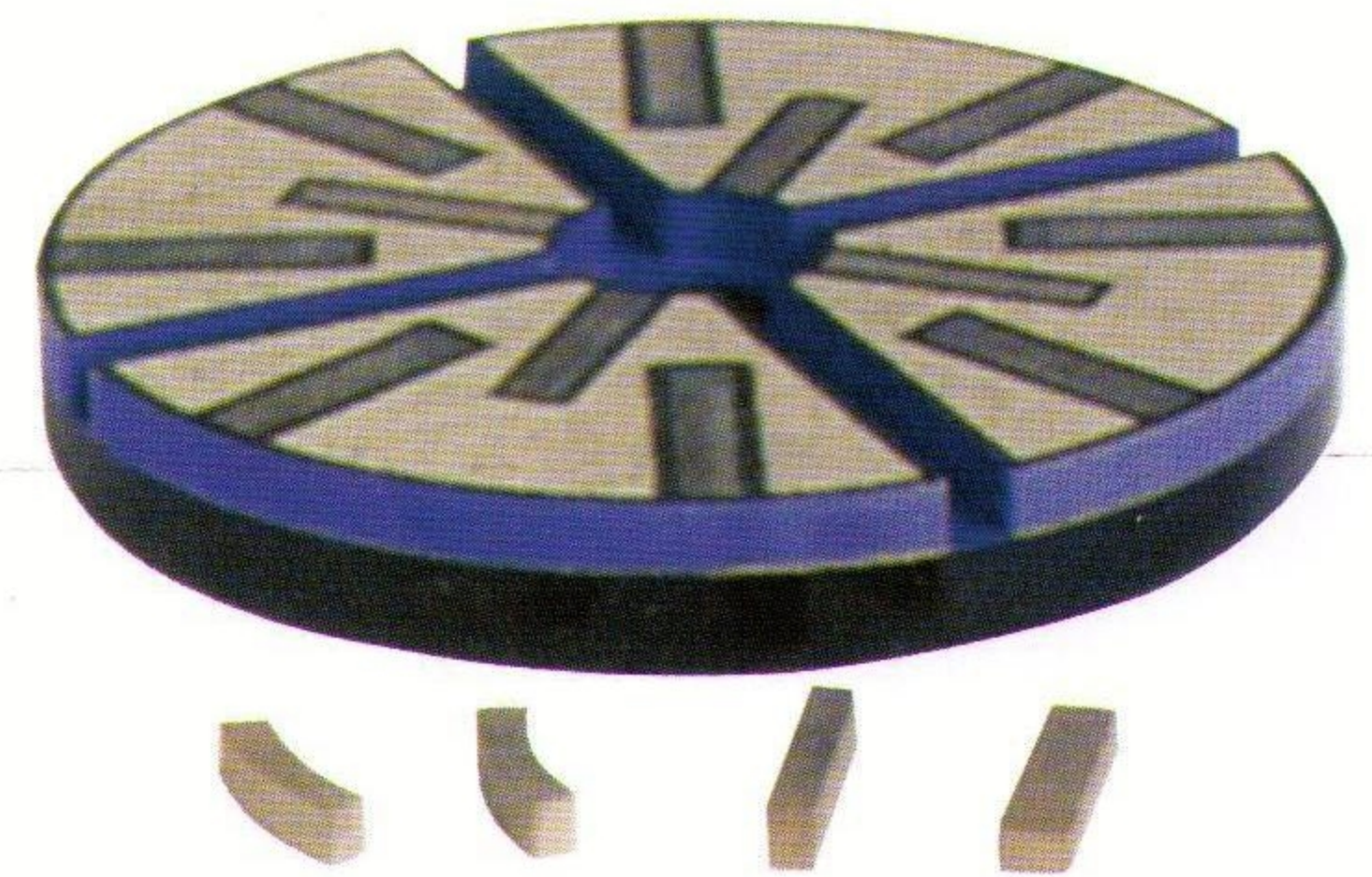

CORONA DESBASTE CON SEGMENTOS

Ref.	Grano	Ø
239990	60, 120, 220, 400	200
239991	60, 120, 220, 400	250

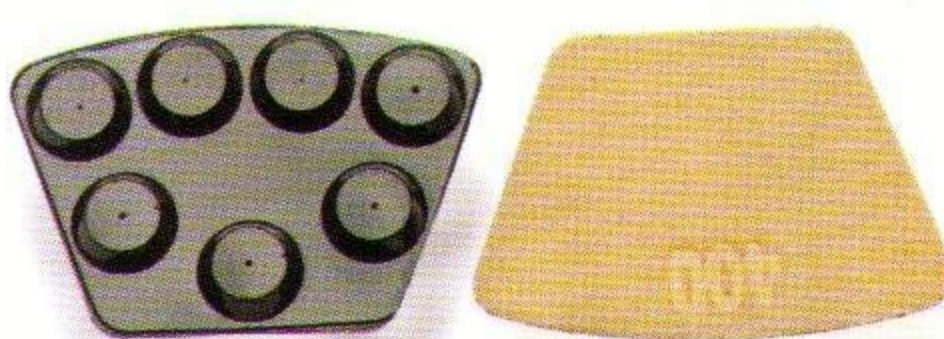

RIÑONES DE DIAMANTE CON VELCRO

Ref.
239939



CORONA DE RESINA BRILLO

Ref.	Color	Ø
239989	marmol y granito	200 - 150



SEGMENTO PARA GRANITO, GRES Y HORMIGON

Ref.	Grano
238805	Medio y grueso



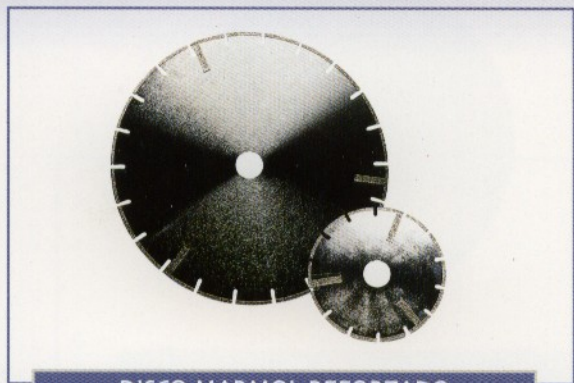

DISCO MARMOL REFORZADO

Ref.	Ø
238801	110, 125, 150, 180, 200, 230

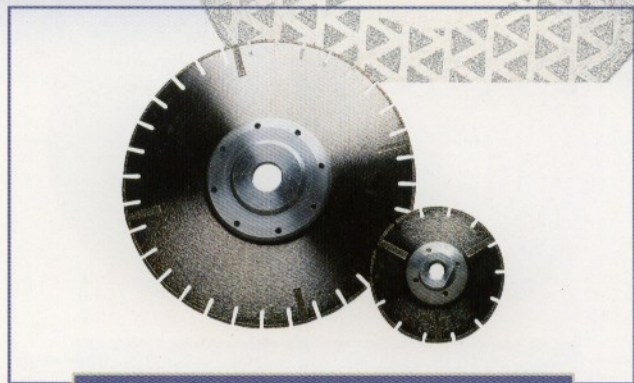

DISCO MARMOL COPA REFORZADO

Ref.	Ø
238744	110
238779	230

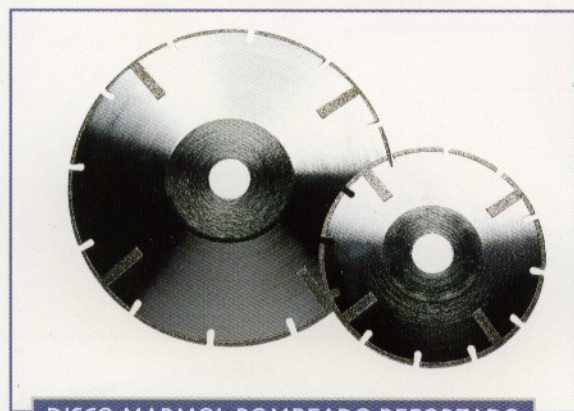

DISCO MARMOL BOMBEADO REFORZADO

Ref.	Ø
238777	125
238778	180

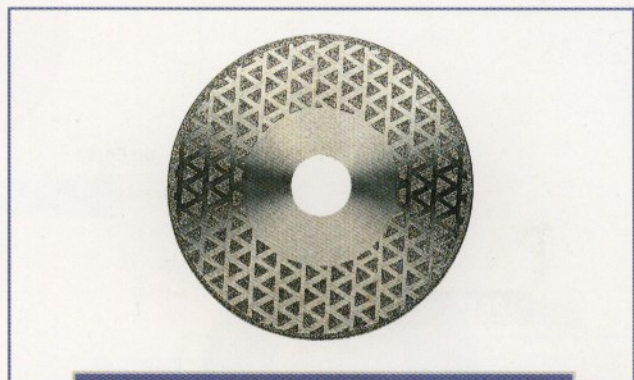

DISCO DE CORTE Y DESBASTE DOBLE CARA

Ref.	Ø
238852	115



FRESA MARMOL CANTO PILASTRA

Ref.	Ø	Grosor
239642	110	5, 10, 15

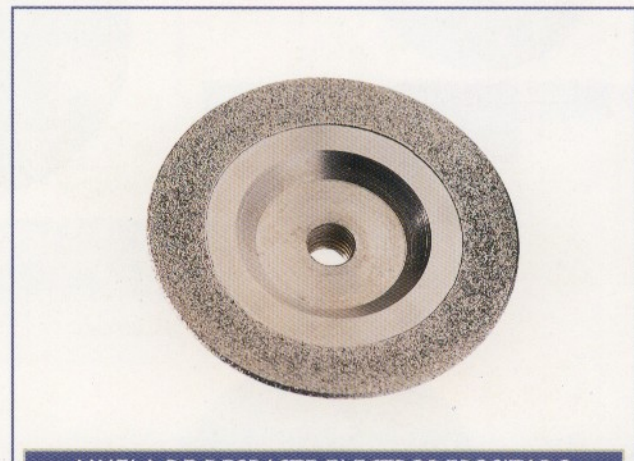

MUELA DE DESBASTE ELECTRODEPOSITADO

Ref.	Ø
239866	100



FRESAS PARA MOLDURAS

Ref.	Ø
239613	Varios



FRESAS MANGO 12 m/m.

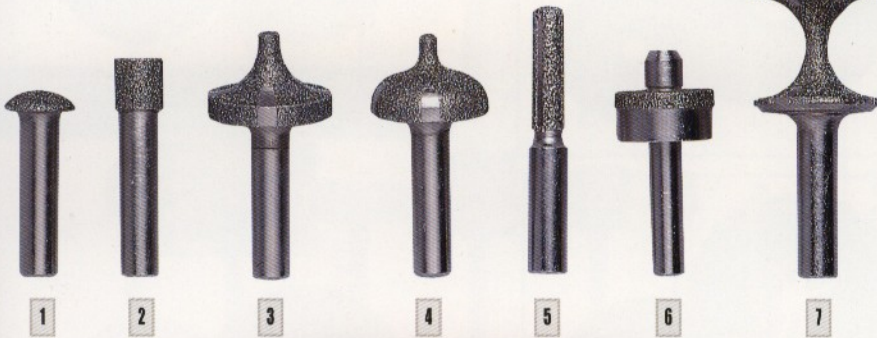

Nº	Ref.	Modelo
1	238890	Acanalar
2	238886	Canto Pilastra
3	238882	Canto Bordón
4	238879	Pecho Paloma
5	238887	De Corte
6	238714	Para Avellanar
7	238885	Canto Romo

DISCO CON ESPÁRRAGO DE 6 mm.

Ref.	Ø
238774	30, 40, 50, 60, 70



FRESOLINES DE DIAMANTE MANGO - 6 m/m



Nº	Ref.
928	238770
930	238772
927	238769
931	238773
929	238771



BROCAS DE LAVABO

Ref.	Ø
238762	20, 31, 35, 40, 50, 55, 60, 65, 70, 80, 90

JUEGO PIVOTES DIAMANTADOS MANGO 6 m/m.

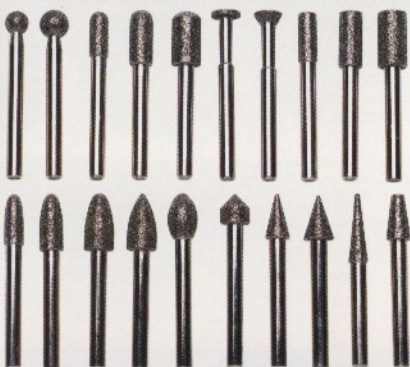

Nº PIEZAS	Ref.
20	239656

PIVOTES - JUEGO MANGO 3m/m.



Nº PIEZAS	Ref.
20	238548

FRESAS PARA MOLDURAS PARA RADIALES

Ref.	Radio	Ø
239999	10 - 15 - 20 - 25	100 - 125



RIÑONES DE DIAMANTE CON VELCRO

Ref.
239939





LIJAS FLEXIBLES

Ref.	Ø	Grano
030065	178	24, 36, 60, 120, 220, 320, 400
038518	110	24, 36, 60, 120, 220, 320, 400

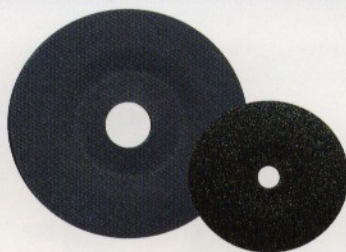

LIJAS RIGIDAS

Ref.	Ø	Grano
038509	110	24, 36, 60, 120, 220
030071	178	24, 36, 60, 120, 220



LIJAS TAF

Ref.	Ø	Grano
038621	110	60, 120, 220, 280, 320
038670	178	60, 120, 220, 280, 320

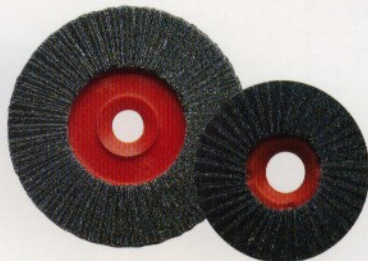

LIJAS ADHESIVAS BELCRO

Ref.	Ø
039099	125
039098	178

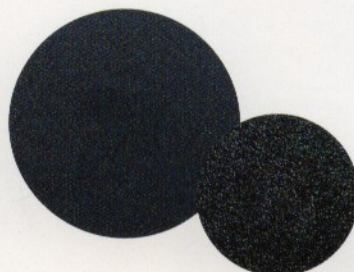

LIJAS RONDELL

Ref.	Ø	Grano
038611	178	30, 60, 100, 180



CEPILLO DE LIJA

Ref.	Ø	Grano
049525	60 x 30	60, 80, 120, 180, 220, 320, 400
048599	165 x 25	60, 80, 120, 180, 220, 320, 400

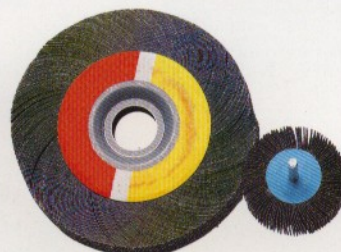

PLATO ENGANCHE RAPIDO CON AMORTIGUADOR

Ref.	Ø
108574	100
108549	130

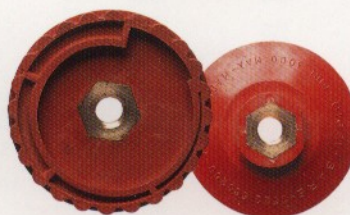

PLATO ENGANCHE RAPIDO PARA PULICANTOS

Ref.	Ø
109987	130

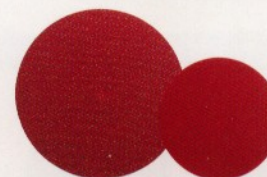

SUPLEMENTOS VELCRO

Ref.	Ø
108572	125, 178

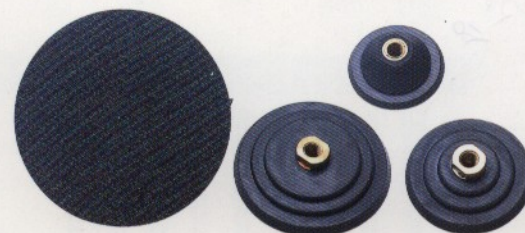

PLATOS DE GOMA CON VELCRO

Ref.	Ø
108583	100, 115, 125 Y 178

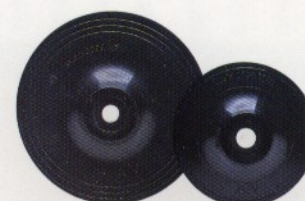

PLATO DE GOMA O CAUCHO

Ref.	Ø
308998	115, 178



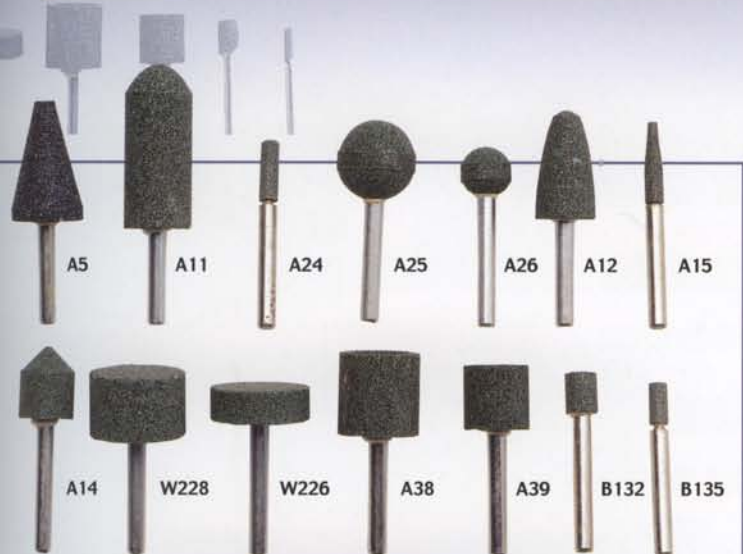

**PIVOTES CARBORUNDUM 6 mm**

Ref.  
049165

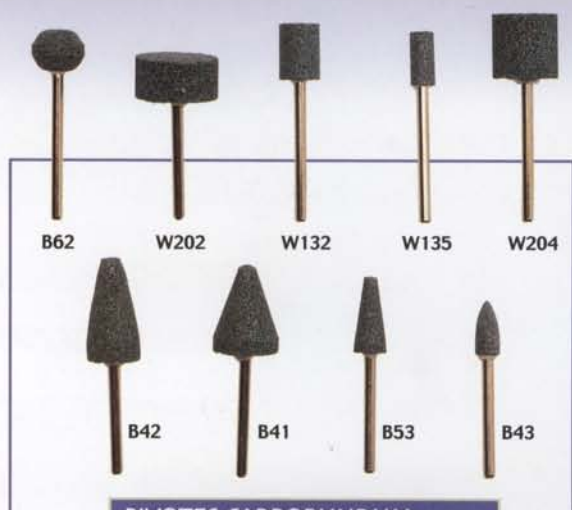

**PIVOTES CARBORUNDUM 3 mm**

Ref.  
049165

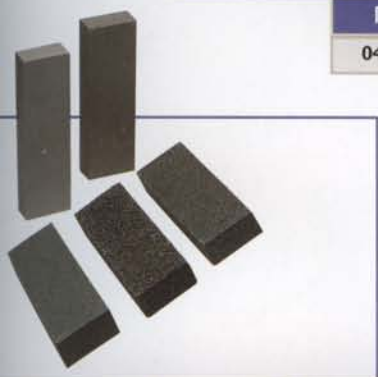

**BRIQUETA DE CARBURO DE SILICIO**

Ref.	Medidas	Gr.
40088	150 x 50 x 25	30, 60, 120, 220
40089	150 x 50 x 25	500



**CILINDRO DE CARBORUNDUM**

Ref.	Granos
049956	36, 60, 120



**PLIEGOS DE LIJAS DE AGUA**

Ref.	Grano
030061	Desde 80 a 1200

## PAPEL Y LIQUIDO RETARDANTE PARA CANTO RODADO



**RETAPEL**  
Ref.  
298940



**FEBOL (Líquido retardante)**  
Ref.  
379036

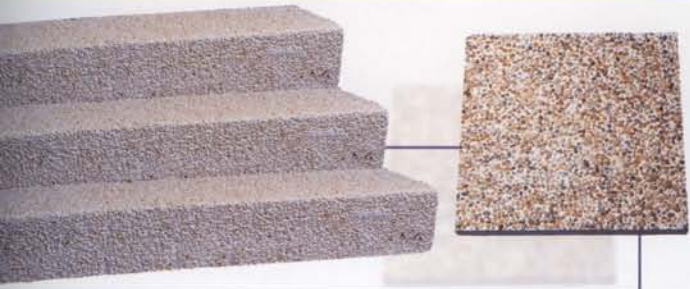

RETAPEL	
Ref.	Medida
298941	40 x 40
298942	50 x 50





Producto para piedra  
Putty for stone  
Betume para piedra



**MASILLAS**

Ref.	Kg.
019237	1,7
019686	7
019687	33



**DIFERENTES COLORES**

**PEGAMENTOS**

Ref.	Kg.
010001	1
010002	6
010003	25



**SILICONA (varios colores)**

Ref.	Contenido
010099	Silicona
019369	Silicona antimanchas



**SPRAY ABRILLANTADOR DE CANTOS**

Ref.
399814

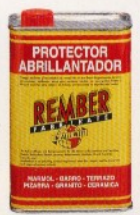

**PROTECTOR ABRILLANTADOR**

Ref.	Kg.
010013	1,5
010014	3
010015	7,5



**CANTEADOR**

Ref.	L.
018962	1,5



**PROTECTOR ANTIPINTADAS**

Ref.	Kg.
018964	1,5



**POLVOS**

Ref.	Color
050097	Rojo, ocre, negro, verde



**QUITACERAS Y QUITAMANCHAS**

Ref.	Kg.
018963	1,5



**ANTIHUMEDAD**

Ref.	L.
019672	4



**DECAPANTE CERAS**

Ref.	L.
019682	1



**TINTE DE COLORES**

Ref.	Color
019339	Naranja, verde, rojo, amarillo, negro, azul



**ENVEJECEDOR**

Ref.	L.
019745	1



**QUITACEMENTOS**

Ref.	L.
019736	1



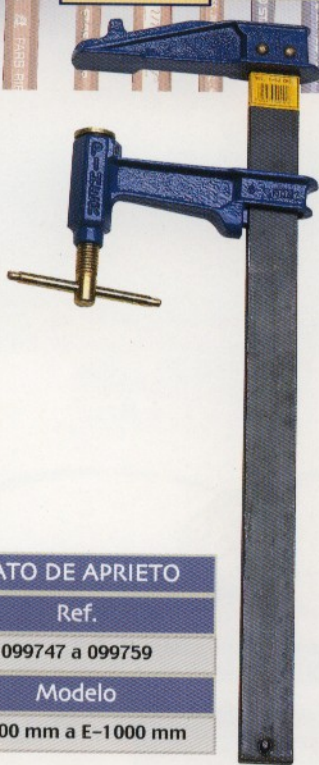

**GATO DE APRIETO**  
 Ref.  
 099747 a 099759  
 Modelo  
 E-100 mm a E-1000 mm

Ref.	49087	
Ref.	449851	
Ref.	449744	
Ref.	449614	
Ref.	449104	
Ref.	449093	
Ref.	449744	
Ref.	449093	

Ref.  
448949

**GATO ESCULTOR**  
 Ref.  
 099501

**MAZO DE GOMA**  
 Ref.  
 099488

**PALETA CATALANA**  
 Ref.  
 099490

**ESPÁTULAS**

Ref.	Medidas
099480	30, 40, 50, 60, 70 y 100 mm

**RASTRILLO SIN MANGO**

Ref.	Medida
309598	40, 60, 80

**CEPILLOS DE ACERO**

Ref. con mango	Ref. sin mango
389052	389051

**NIVEL (Distintas medidas)**  
 Ref.  
 099504

**PASTA LAVAMANOS**

PASTA	
Kg.	Ref.
900gr.	019455



GRAPAS VARILLA DE 3 mm

Nº	REF.	Longitud
19	020043	90 mm
20	020043	100 mm
21	020043	120 mm
22	020043	140 mm
23	020043	150 mm
24	020043	160 mm



PISTOLA MASILLA ESPECIAL

Modelo	Ref.
380	019575

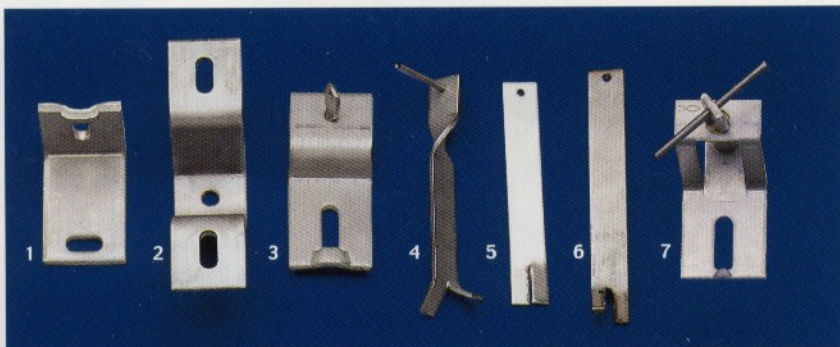

GRAPAS DE PLETINA

Ref.
029475

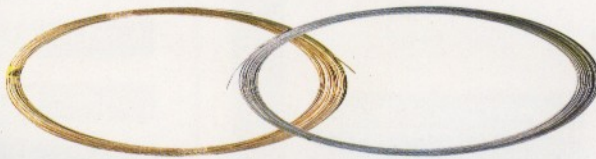

ALAMBRE LATÓN

Ref.
549127

ALAMBRE GALVANIZADO

Ref.
549128

ALAMBRE ACERO INOXIDABLE

Ref.
549957

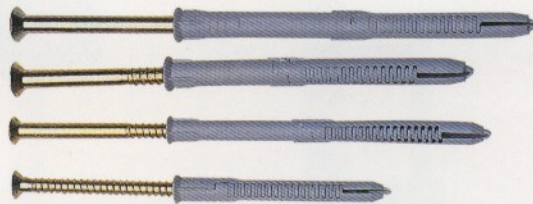

TORNILLO CON TACO FISHER

Ref.	Ø	Largos
099507	10	80, 100, 115, 135, 160, 185, 200 y 230



GRAPA PARA NIVELACION DE SOLADOS

Ref.
029934

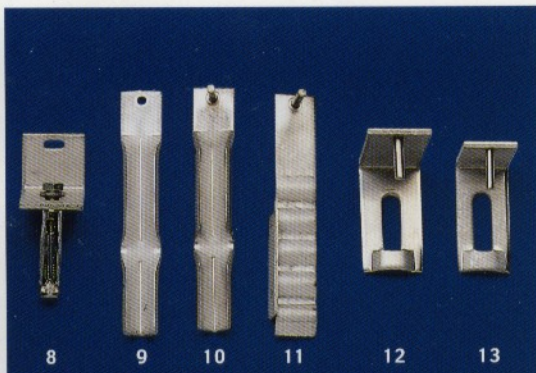

GRAPAS DE PLETINA

Ref.
029475



CINTA PERFORADA

Ref.
549869

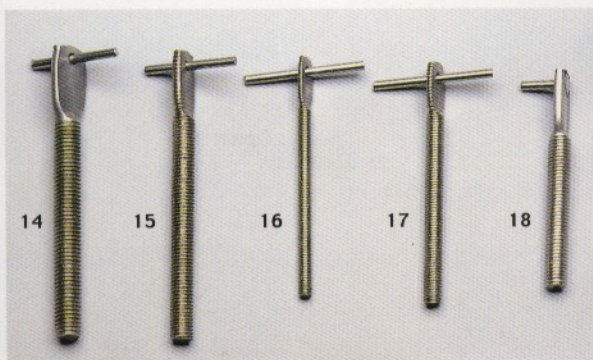

GRAPAS ROSCADAS

Ref.	
029457	
Nº	Ø
14	12 x 120
15	10 x 120
16	6 x 100
17	8 x 100
18	12, 10, 8 y 6

A	Tornillo para hormigón	099088
B	Casquillo rígido	099941



**PULIDORA DE AGUA MINI**

VÁLIDO PARA PLATO VELCRO Ø75, 100, 115 mm

Ref.	R.P.M. Max.	Consumo aire
309832	4500	220 L/min.

Con REGULADOR DE REVOLUCIONES

**LIJADORA**

PLATO VELCRO DE Ø 180 mm

Ref.	R.P.M. Max.	Consumo aire
309834	4200	110 L/min.



**RADIAL**

Ref.	R.P.M. Max.	Consumo aire
309833	6000	1020 L/min.

**PULIDORA DE AGUA**

HASTA PLATO Ø 125 mm

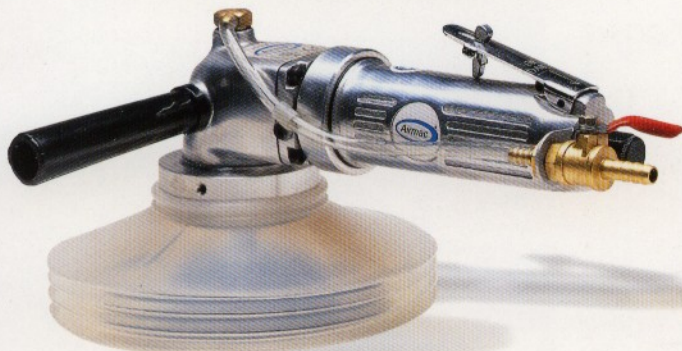
Ref.	R.P.M. Max.	Consumo aire
309835	1800	640 L/min.
309836	4200	640 L/min.

**AMOLADORA ANGULAR MINI**

PINZA PARA PIVOTE DE 6 mm

Ref.	R.P.M. Max.	Consumo aire
309839	6000	1020 L/min.

**RADIAL DE AGUA**

HASTA PLATO Ø 125 mm

Ref.	R.P.M. Max.	Consumo aire
309837	11500	650 L/min.

**AMOLADORA RECTA MINI**

PINZA PARA PIVOTE DE 6 mm

Ref.	Consumo aire
309838	220 L/min.





## JUEGO AMOLADORA ANGULAR MINI

Con pinzas de 3 y 6 mm

Ref.	CONSUMO DE AIRE
309843	280 L/min.

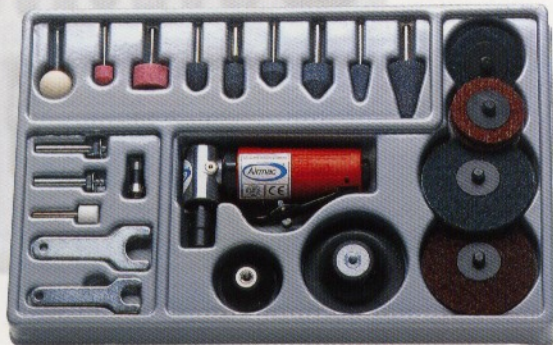

## JUEGO DE PISTOLETE

Redondo Ref.	Exagonal - Ref.	CONSUMO DE AIRE
309845	309844	110 L/min.



## JUEGO AMOLADORA RECTA

Con pinzas de 3 y 6 mm

Ref.	CONSUMO DE AIRE
309842	220 L/min.



## JUEGO AMOLADORA micro

Con pinzas de 3 mm

Ref.	CONSUMO DE AIRE
309846	160 L/min.



## MANGUERA MUELLE

Ref.	Longitud
309841	2 m.



## PISTOLA DE SOPLAR

Ref.
309848

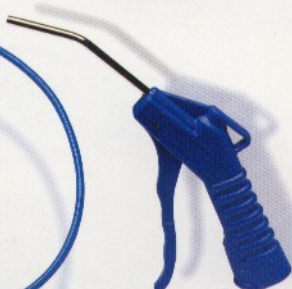

## Ref.

309850



309849



309851



## HERRAMIENTA EXAGONAL 175 mm(Unidad)

Ref.
309852



## MANGUERA ALARGADOR Largo 30m

Ref.
309840





HITACHI



CORTADORA

Modelo

CM-6



FRESADORA

Modelo

M-12-SA



LIJADORA

Modelo

S-18-SA

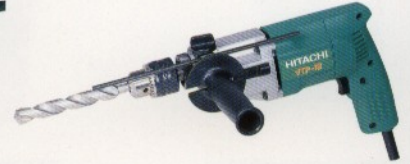

TALADRO

Ref.

VTP-18

BOSCH



TALADRO

Modelo

GBH2SE



TALADRO

Modelo

GBH3-28E



TALADRO CON BATERIA

Modelo

GBH-24VFR



MARTILLO ROMPEDOR

Modelo

GSH11E



TALADRO

Modelo

GSB20-2



TALADRO

Modelo

PBH-220RE



AMOLADORA RECTA

Modelo

GG5-27C



RADIAL

Modelo

GW523-230J

Revoluciones

1800 - 2300



RADIAL

Modelo

GWS7115



RADIAL CON REGULADOR DE REVOLUCIONES

Modelo

GPO-12E

METABO



TALADRO

Modelo

00652005-50



FLEX



TALADRO AGUA

Modelo  
BHW-1541



TRANSFORMADOR

Ref.  
188996



PULIDORA AGUA

Modelo  
LW 1503



PULIDORA MINI AGUA

LW 1202

MAKITA



SIERRA CIRCULAR

Modelo  
4101R



RADIAL

Modelo  
AS24-PBF



MINI RADIAL

Modelo  
956-4Z



TALADRO

Modelo  
HP2010N

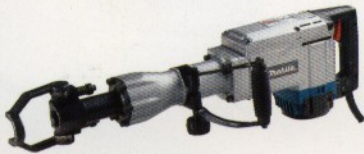

MARTILLO DEMOLEDOR

Modelo  
HM1 303-B



AMOLADORA RECTA

Modelo  
GD-0800C



LIJADORA

Modelo  
92185B



LIJADORA Y PULIDORA

Modelo  
GV7000C



ENROLLACABLES

Ref.  
549213



CARCASA DE AGUA

Ref.	Ø
269333	115 ó 125
269334	230

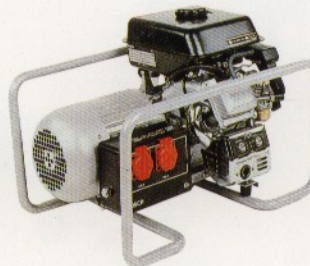

GRUPO ELECTROGENO

Ref.	Modelo
278913	G 2400 S



AFILADORA DOBLE MUELA

Ref.  
138623



ESCOBILLAS



PULIDORA DE PELDAÑOS



Ref.

308938

PULIDORA DE PISO TRIFASICA MOTOR 5.5 C.V.



Ref.

308944

ABRILLANTADORA DE PISOS

Ref.	Modelo
308943	B - 300 Ø
308954	B - 460 Ø
308955	B - 500 Ø



PULIDORA DE PISO MONOFASICA MOTOR 3. C.V.



Ref.

308960





Ref.	Kg.	Descripción
399174	5	A 7 - CERA PLASTICA
399173	5	A 9 - CONSERVADOR AZUL
399519	1,8	C 1 - CANTEADOR
399175	6	D 1 - DECAPANTE



Ref.	Kg.	Descripción
399172	6	X 1 AC - DECAPANTE
399520	6	X 2 - CRISTALIZADOR
399519	6	X 3 - CRISTALIZADOR
399521	6	X 4 - CRISTALIZADOR
399123	6	X 5 - CRISTALIZADOR



CRISTALIZADOR - P 11

Ref.
399118



LANA DE ACERO FINA Y GRUESA

Ref.
409085



DISCO ABRILLANTADOR

Ref.	Ø	Descripción
399384	330	DISCO BLANCO
399385	505	DISCO BLANCO
399386	330	DISCO NEGRO
399387	505	DISCO NEGRO

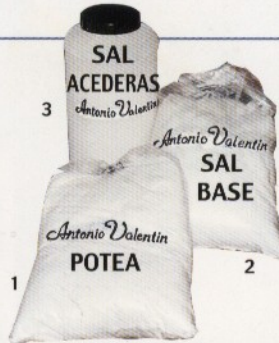

POTEA EN POLVO

Nº	Ref.
1	05101
2	06106
3	06102

PULIMENTIN

Ref.
399122



POTEAS EN BARRA DE DISTINTOS COLORES

Ref.
050101

POTEAS DE TRAPO

Ref.	Ø
439661	125
439074	178

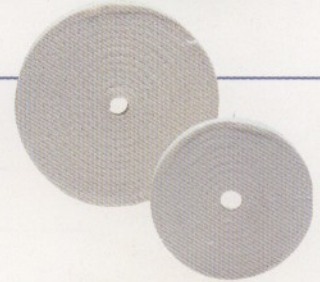

PLATO CON FIELTRO

Ref.	Ø
109171	125
108594	178

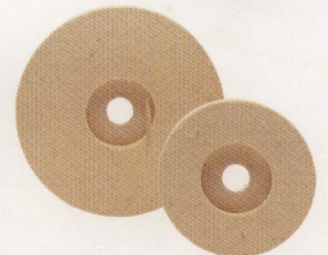

BOINAS PIEL DE BORREGO

Ref.	Ø
108739	178
109659	125





**ESPARTO**

Ref.	Ø	Descrip.	Ref.	Descrip.	Ø
218729	130 mm	con plomo	218727	sin plomo	250 mm
218725	130 mm	sin plomo	218732	con plomo	300 mm
218730	200 mm	con plomo	218728	sin plomo	300 mm
218726	200 mm	sin plomo	218724	con plomo	350 mm
218731	250 mm	con plomo	218723	sin plomo	350 mm

**PULIDORA DE SUELO  
CORONAS ROJAS Y NEGRAS**

Ref.	Ø	Granos
208686	200	30, 60, 120, 220
208694	250	

**PLATO DE HIERRO**

Ref.  
108591

**FLECTOR DE CAUCHO**

Ref.  
088598

**PLATO PARA ENVEJECER**

Ref.	Ø	Granos
109804	125	60 - 120 - 240
109807	250	60 - 120 - 240

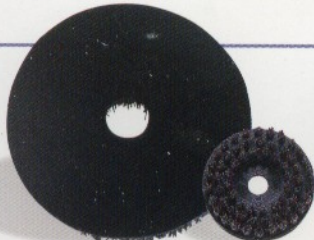
**FIELTROS**

Ref.	Ø
429063	100 x 40 mm
429065	150 x 40 mm
429066	200 x 40 mm
429067	250 x 40 mm
429068	350 x 40 mm

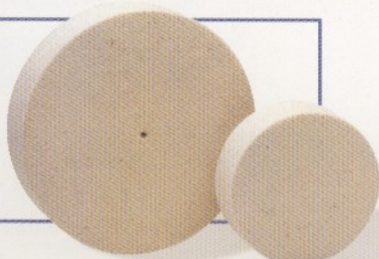
**MUELA DE VASO (distintos granos)**

Ref.	Ø	Granos
048513	100	24, 26, 60, 120, 220, 400, 600

**CORONA IF BRILLO GBS**

Ref.	Ø	Granos
209560	100 X 35	60, 1200

**PLATO ENGANCHE RAPIDO**

Ref.	Ø
108574	100

**CORONA IF**

Ref.	Ø	Granos
209561 a 209568	100 X 35	60 al 1200

**CORONA DE MAGNESITA**

Ref.	Ø	Granos
208678	130, 200, 250	30, 60, 120, 220, 320, 400, 600, 800, 1000

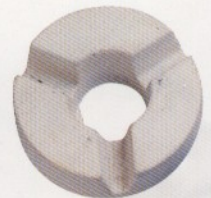
**PLATO DE HIERRO PARA PEGAR CORONAS**

Ref.  
108586

**PLATO ENGANCHE RAPIDO**

Ref.	Ø
1095449	130

**AMORTIGUADOR Y TORNILLO DE ARRASTRE**

Ref.  
088595

Ref.  
088585







CORTADORAS PORTÁTILES

Ref.	Medida en cm
269663	65, 85, 100, 120, 200



CHORRO DE ARENA CON ASPIRACIÓN INCORPORADA PARA GRABAR EN MARMOL Y GRANITO

Ref.  
309680



MICROCHORRO PEQUEÑO 6 GRANDE

Ref.  
309952



CHORRO DE ARENA MANUAL

Ref.  
309955





ARENA DE SILICE

Ref.  
059881



CORINDON

Ref.  
050094



CEPILLOS  
Ref.  
389055



BOQUILLAS  
Ref.  
389004



GOMA  
Ref. Medida  
529271 19,4 x 762 mm



PEGAMENTO PARA GOMA  
Ref.  
010090





CARRO DE TABLEROS

Ref.

149938



CARRO GRANDE

Ref.

148857

Fabricación Propia



CARRETILLA 2 RUEDAS

Ref.

148856



CARRO DE PINZAS

Ref.

148859



CONTENEDOR DE RESIDUOS TRANSPORTABLE

Ref.

149965



CARRA PEQUEÑA

Ref.

148858



PORTATABLEROS

Ref.

149860





CE

Fabricación Propia

PINZAS

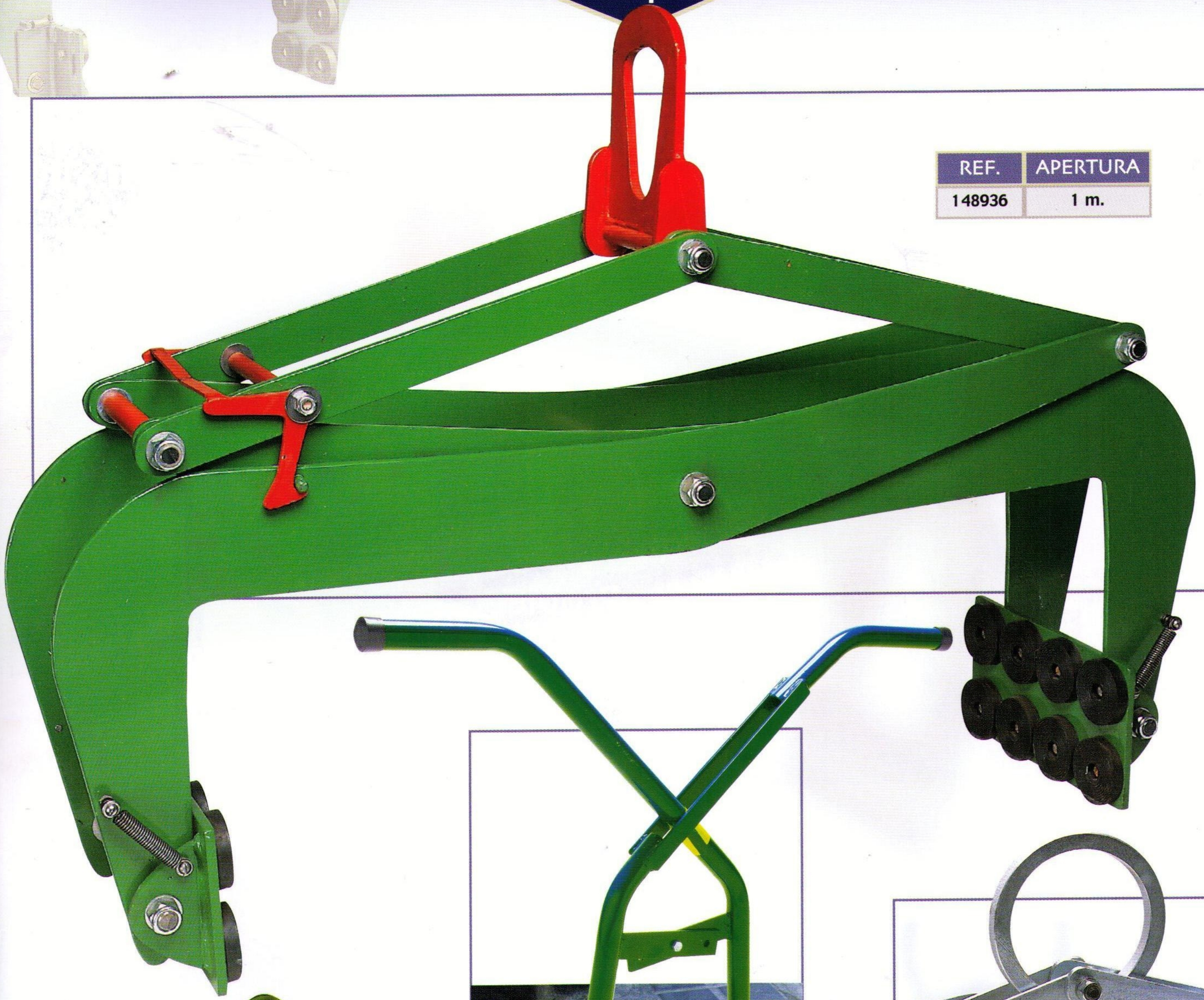

REF.	APERTURA
148936	1 m.

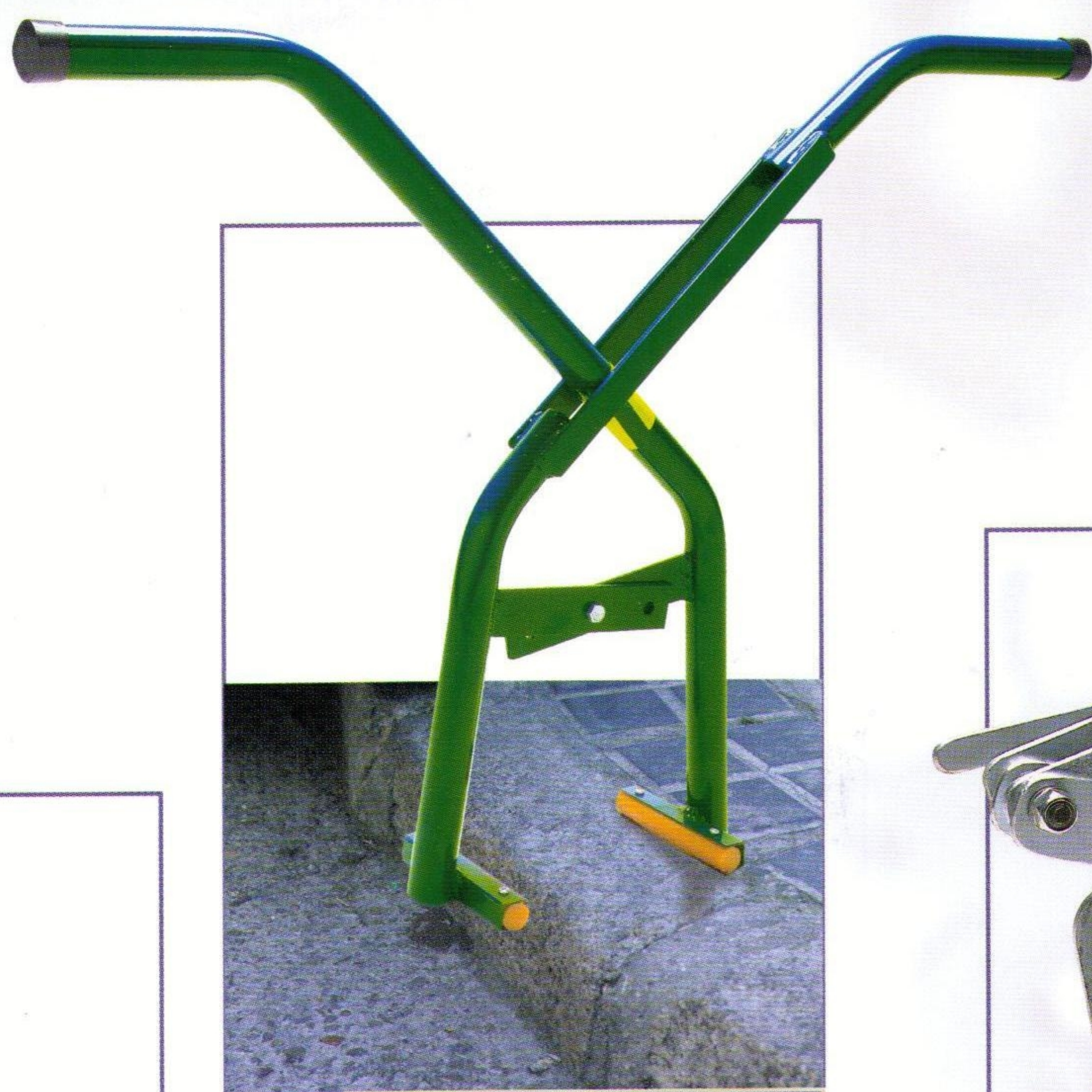

PINZA PARA BORDILLOS

Ref.
148702



PINZA GALVANIZADA

REF.	APERTURA
148937	9,5 cm

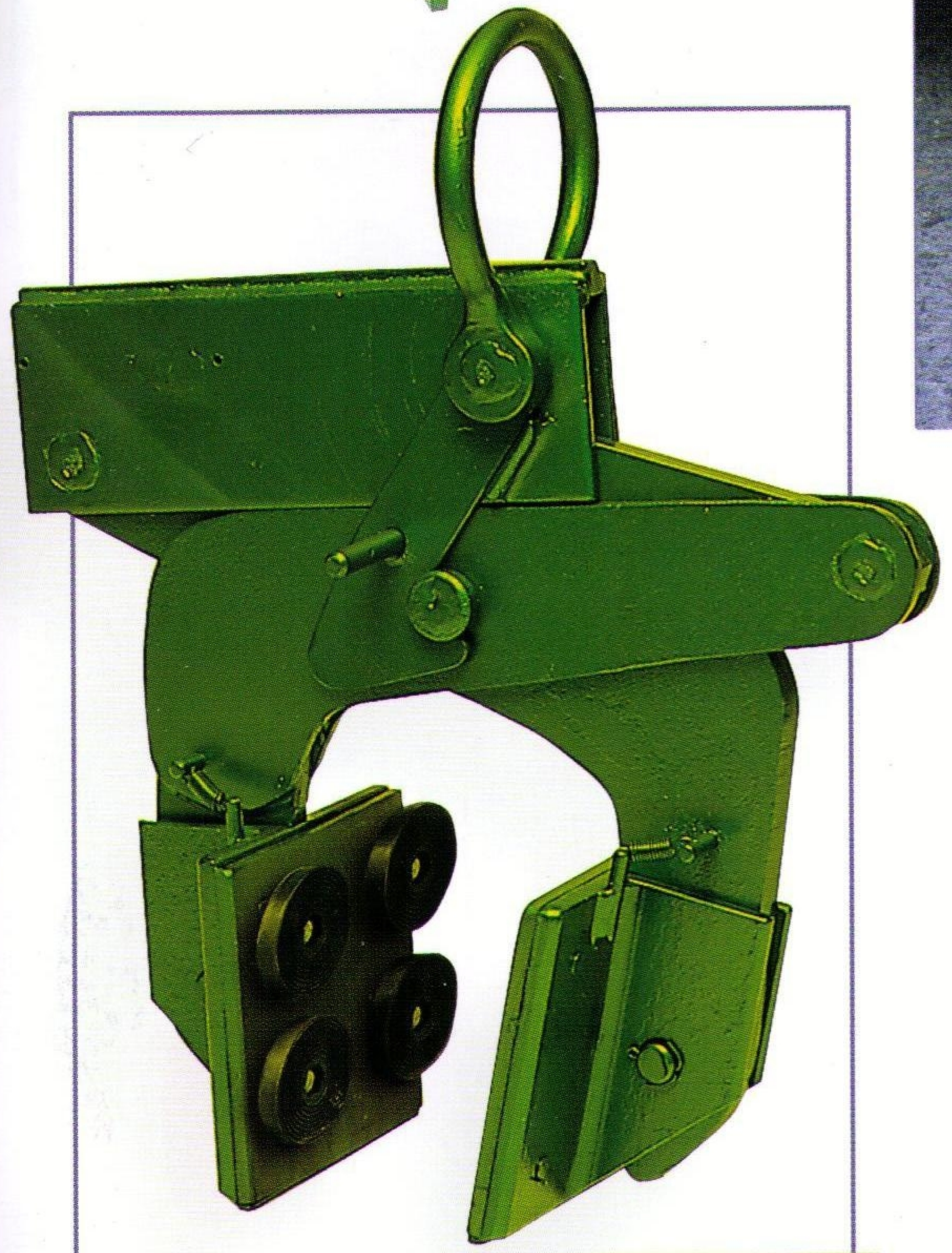

REF.	APERTURA
148860	11 cm



Existencias en color blanco

REF.	Ø
148862	8 cm



REF.	Ø
148862	5 cm



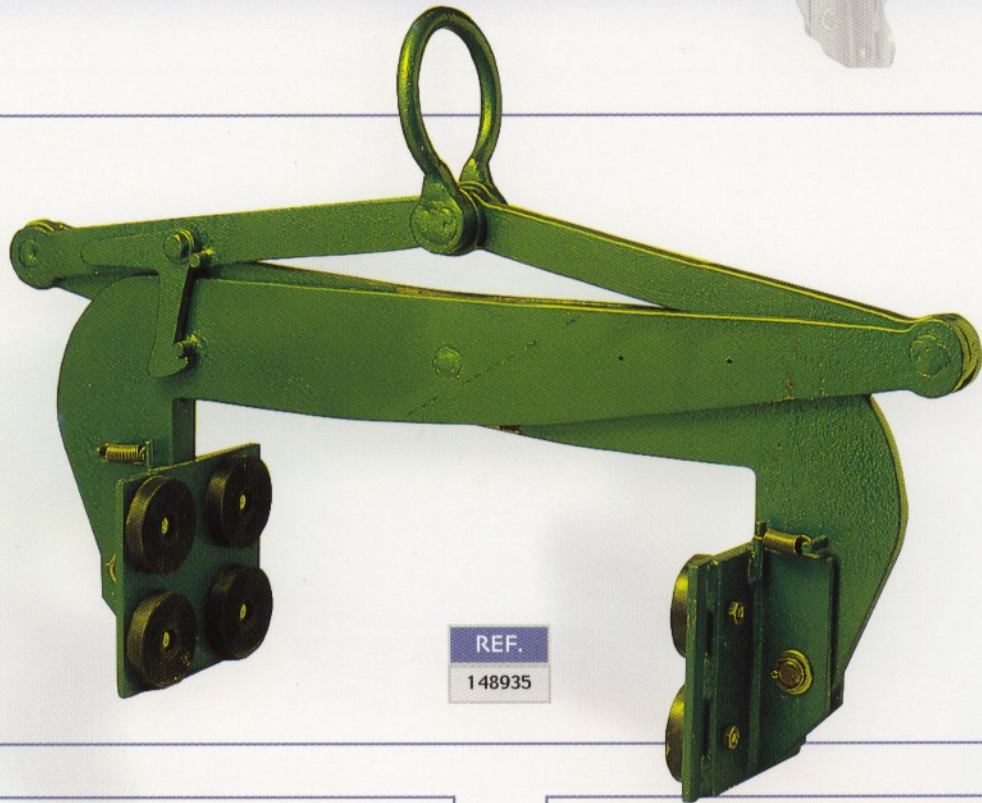

REF.  
148935

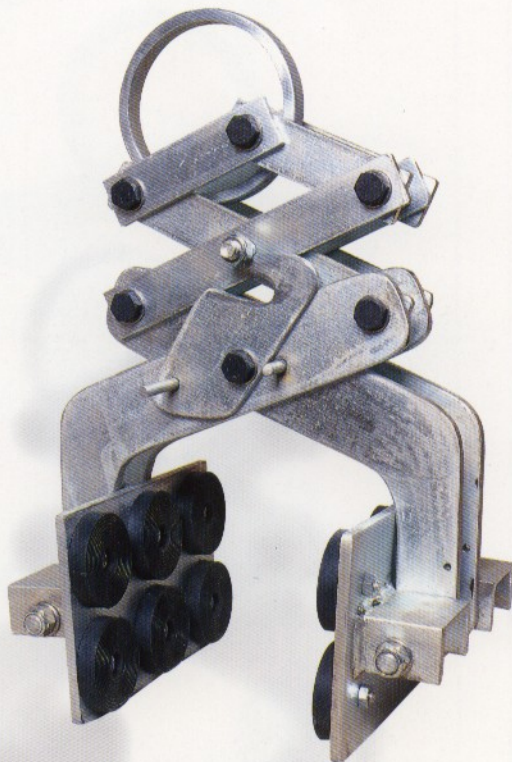

PINZA GALVANIZADA

REF.  
149975

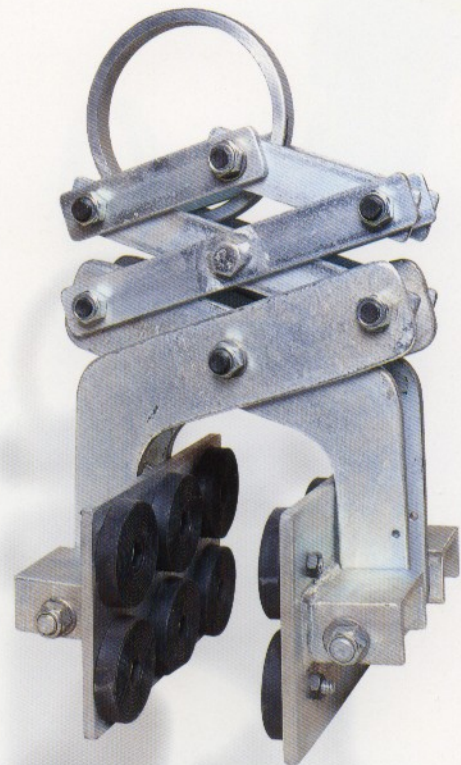

PINZA GALVANIZADA

REF.  
149976





[ kg ]	Cada 30 mm. de anchura de la banda, 1000 Kg de C.M.U.
1000	30 mm
2000	60 mm
3000	90 mm
4000	120 mm
5000	150 mm
6000	180 mm
8000	240 mm
10000	300 mm

Forma B de SpanSet = Forma B2N - banda doble según la Norma DIN

ESLINGAS NYLON		
Ref.	Medida	Ancho
459620	2 m	7 cm
459090	2 m	10 cm
459111	3 m	7 cm
459091	3 m	10 cm
459112	4 m	7 cm
459092	4 m	10 cm
459115	5 m	7 cm
459094	5 m	10 cm
459116	6 m	7 cm

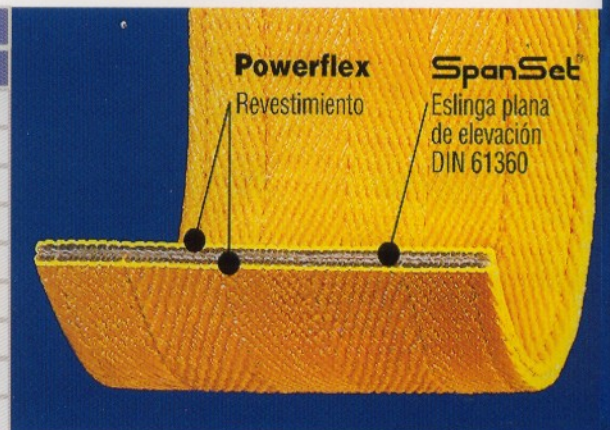
**ESLINGA DE ACERO**

Ref.	Medidas
459106	2 m.
459109	3 m.
459110	4 m.
459117	5 m.



**TENSORES**

Ref.
459114

**GATO DE CREMALLERA**

Ref.	Peso Maximo
339019	5 toneladas
339020	10 toneladas

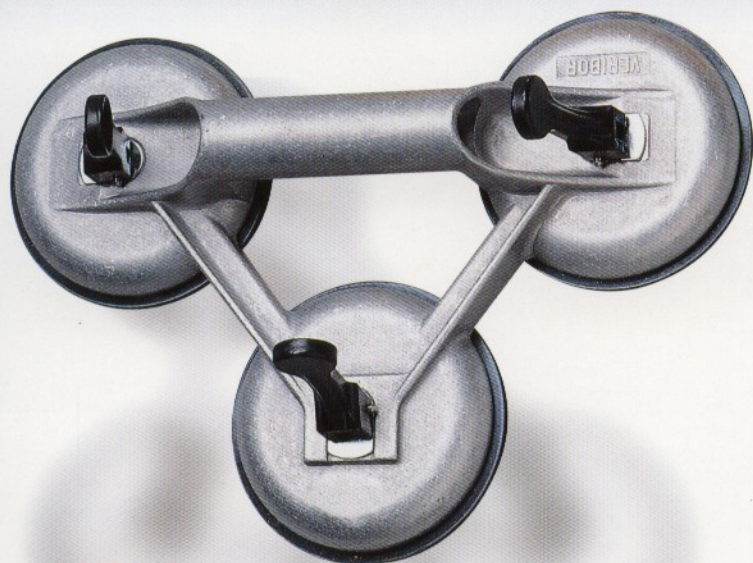



Ref.	Modelo	Ø	Peso máximo
309605	C	3X120	140 Kg

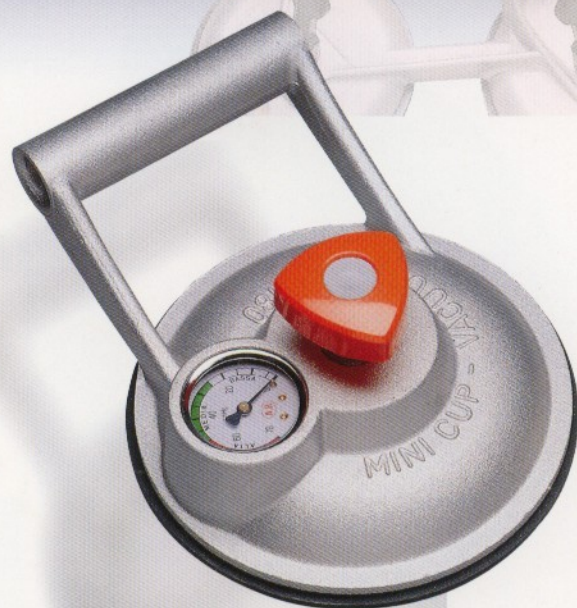

Ref.	Modelo	Ø	Peso máximo
309606	D	180	180 Kg

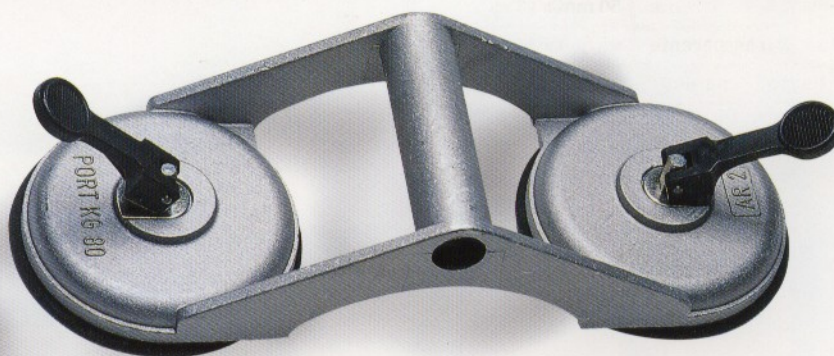

Ref.	Modelo	Ø	Peso máximo
309604	B	2X120	80 Kg



Ref.	Modelo	Ø	Peso máximo
309609	H	120	30 Kg



Ref.	Modelo	Ø	Peso máximo
309612	P	300	300 Kg



Ref.	Modelo	Ø	Peso máximo
309603	A	120	40 Kg





1

2

3

CINTA ANTIDESLIZANTE			
Nº	Ref.	Colores	Medida
1	529522	Negro, Transparente	50 mm x 18 m
2	529268	Negro, Transparente	25 mm x 18 m
3	529830	Negro y Amarillo	50 mm x 18 m

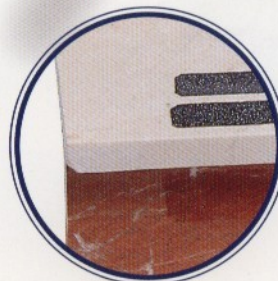

Detalle de colocación



CARBORUNDUM

Ref.

409061



TIRA DE GOMA ANTIDESLIZANTE PARA PELDAÑOS

Ref.

529517

CINTA ANTIDESLIZANTE DE GOMA			
Nº	Ref.	Medida	Colores
1	529523	25 x 8 mm	Azul, Gris, Negro
2	529524	40 x 7 mm	Azul, Gris, Negro



CINTA ANTIDESLIZANTE DE GOMA			
Nº	Ref.	Medida	Colores
1	529518	25 x 8 mm	Marrón, Gris, Negro







**CASCO**  
Ref.  
329829

**VISERA**  
Ref.  
329072



**FAJA**  
Ref.  
329782



**TRAJE DE AGUA**  
Ref.  
329126



**BOTA DE AGUA**

Ref.	Descripción
329013	Sin forrar/ Sin puntera
329011	Forrada/ Sin puntera
329012	Forrada/ Con puntera
329988	Sin forrar/ Con puntera



**BOTAS DE PROTECCION**

Nº.	Ref.
1	329010
2	329977



**CHALECO REFLECTANTE**  
Ref.  
329784



**DELANTAL TRICOLOR**  
Ref.  
419935



**MANGUITOS**  
Ref.  
329096



**DELANTAL CON BOLSILLOS**  
Ref.  
419936



**GUANTES DE GOMA**

Ref.	Nº
329780	1
329786	2
329785	3
329776	4
329777	5
329853	6



GUANTE ESPECIAL  
PARA CABINA DE  
CHORRO DE ARENA

**GUANTES AMERICANOS**

Ref.	Nº
329075	7

**GUANTES DE CUERO**

Ref.	Nº
329079	8

**PROTECTOR DE OIDOS**

Ref.	Nº
329822	1
329821	2
329824	3
329783	4

**MASCARILLAS**

Ref.	Nº
329823	1
329816	2
329781	3
329778	4
329779	5
329059	6
329069	7



Disponibles cristales de repuesto

**GAFAS**

Ref.	Nº
329818	1
329082	2
329819	3
329820	4
329817	5



## MASILLA DE DIFERENTES COLORES

Ref.

239656

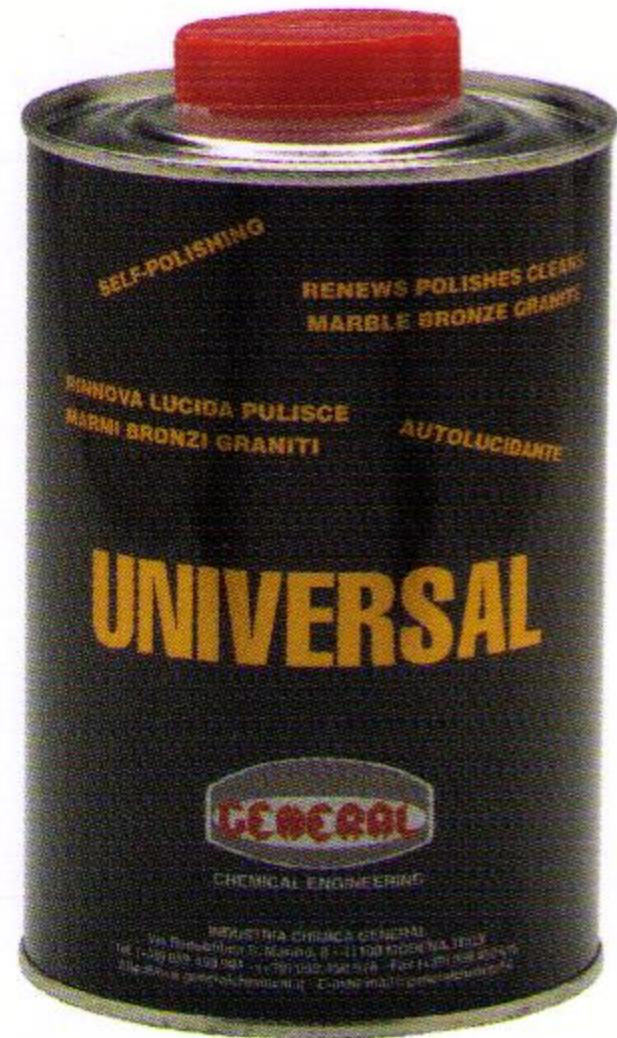

ABRILLANTADOR,  
EFECTO  
ANTIESTÁTICO

Ref. LIQUIDO

018692 1 L.

Ref. SPRAY

018693 400 ml.



ABRILLANTADOR  
DE CANTOS

Ref.

18695



RESINA DE DOBLE COMPONENTE  
CON PISTOLA

Ref.

018687



PROTECTOR  
ANTI-MANCHAS

Ref.

018690



LIMPIADOR ANTI-  
MANCHAS

Ref.

18696



ÓLEO-  
HIDROREPELENTE  
ANTIMANHA,  
IMPREGNANTE

Ref.

018698



IMPREGNANTE,  
HIDRO-  
REPELENTE,  
REAVIVANTE

Ref.

018689

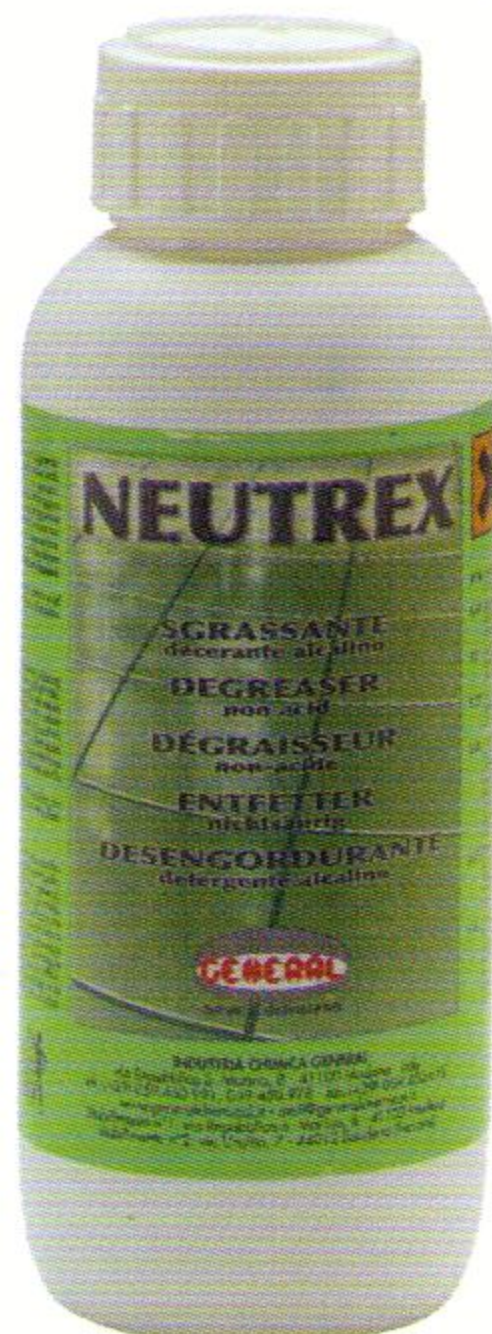

DETERGENTE  
DESENGRASANTE  
CON DISOLVENTES

Ref.

018691



SPRAY PARA  
LIMPIEZA Y  
PROTECCIÓN DIARIA  
DE ENCIMERAS DE  
COCINA Y BAÑO

Ref.

018699



PROTECTOR DE  
ENCIMERAS

Ref.

18697



HIDROREPELENTE

Ref.

018684



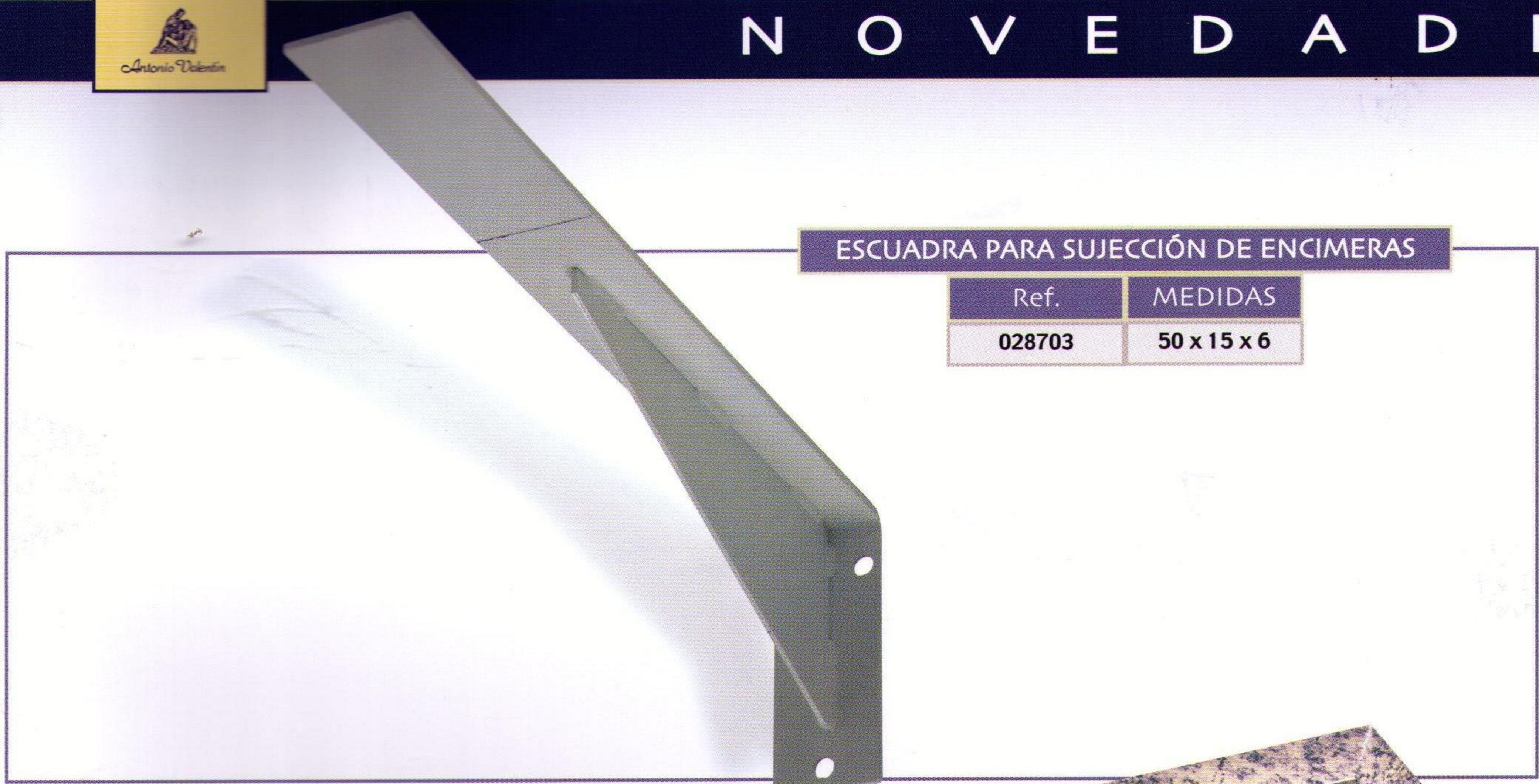

ESCUADRA PARA SUJECCIÓN DE ENCIMERAS

Ref.	MEDIDAS
028703	50 x 15 x 6

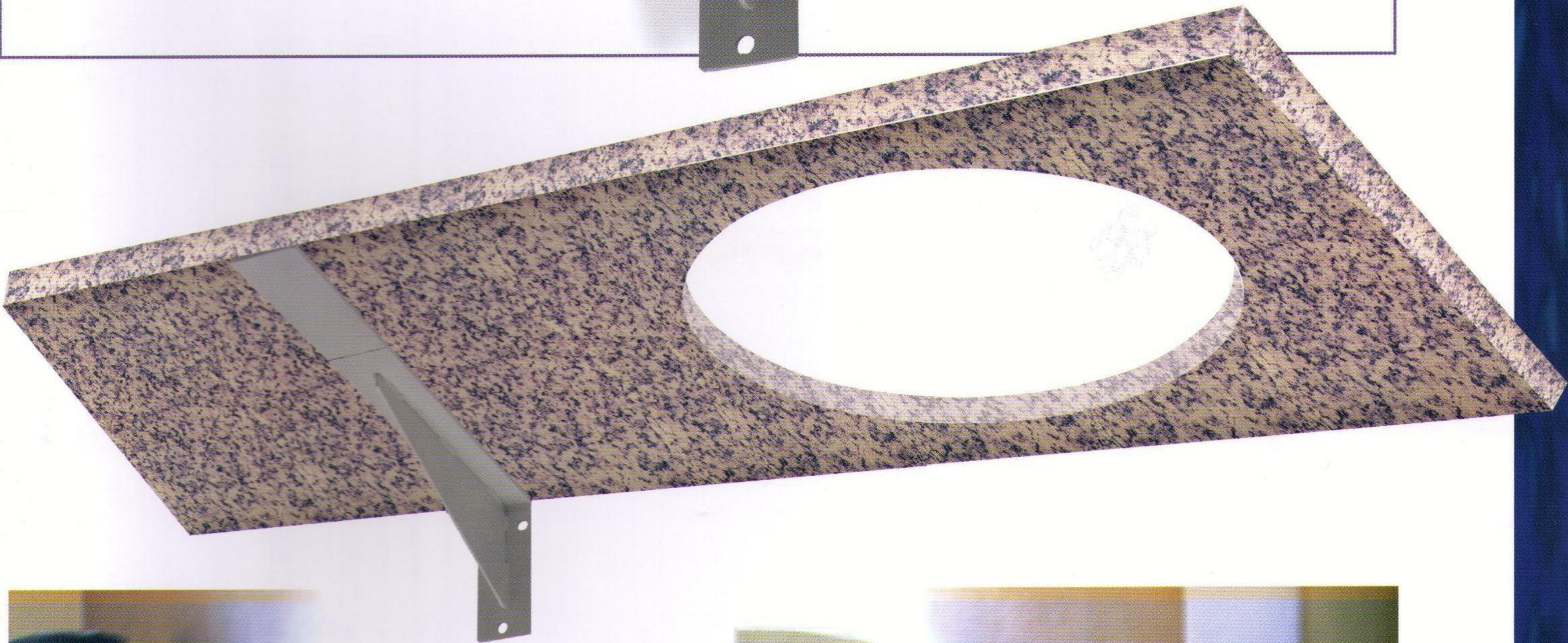



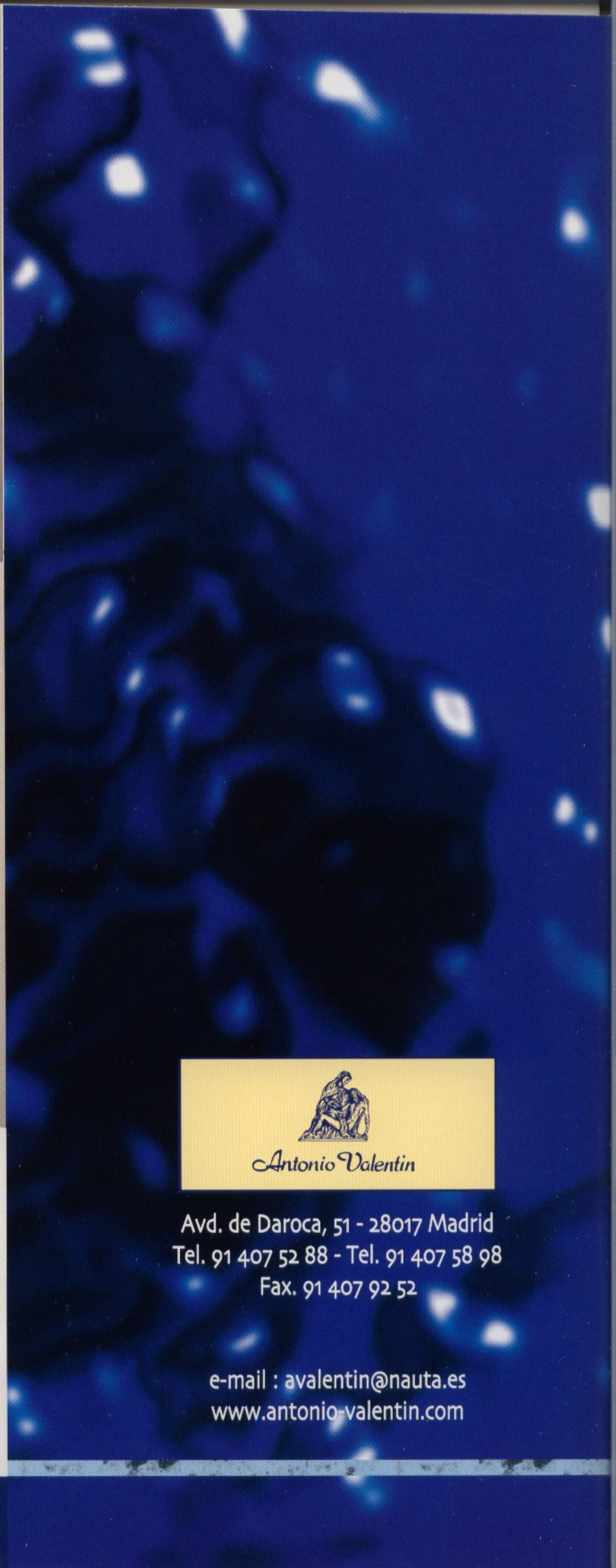
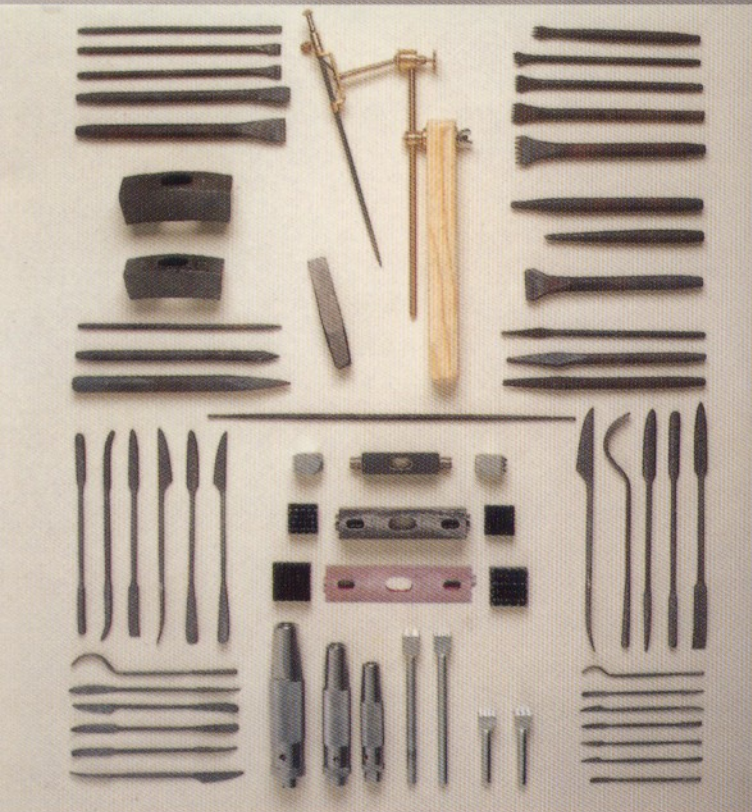

Avd. de Daroca, 51 - 28017 Madrid  
Tel. 91 407 52 88 - Tel. 91 407 58 98  
Fax. 91 407 92 52

e-mail : [avalentin@nauta.es](mailto:avalentin@nauta.es)  
[www.antonio-valentin.com](http://www.antonio-valentin.com)